

La vida secreta de las fragancias

Ricardo Diez

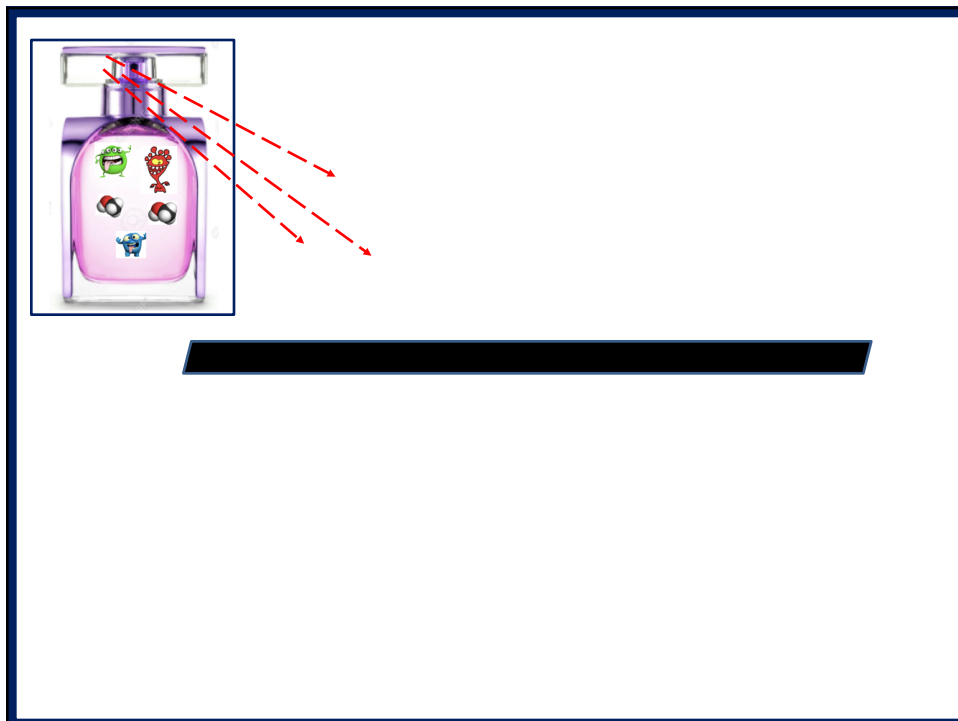

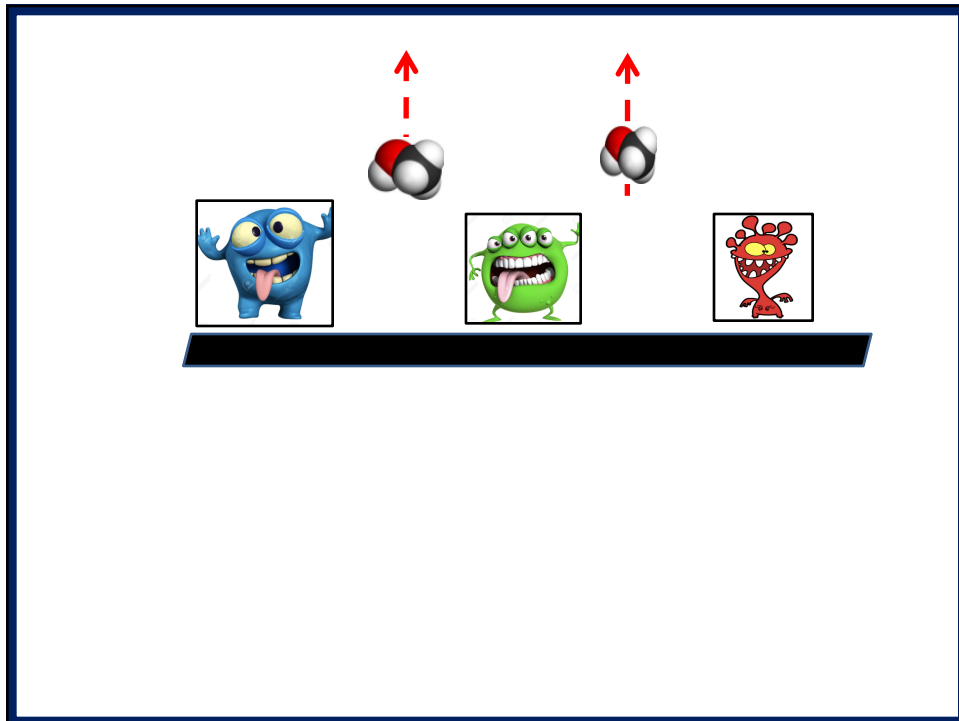

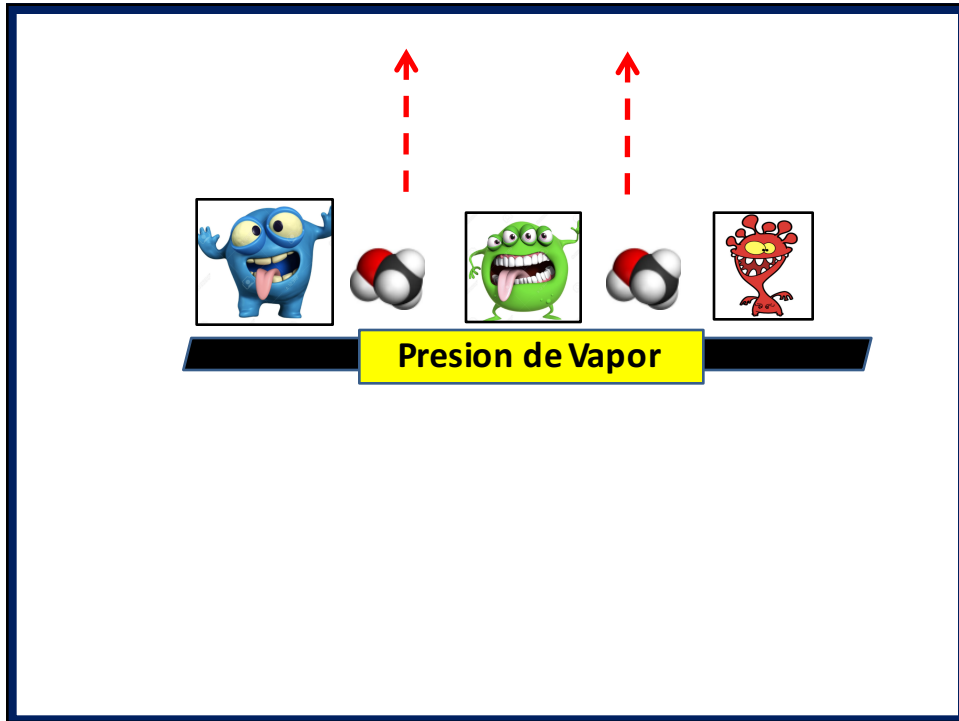

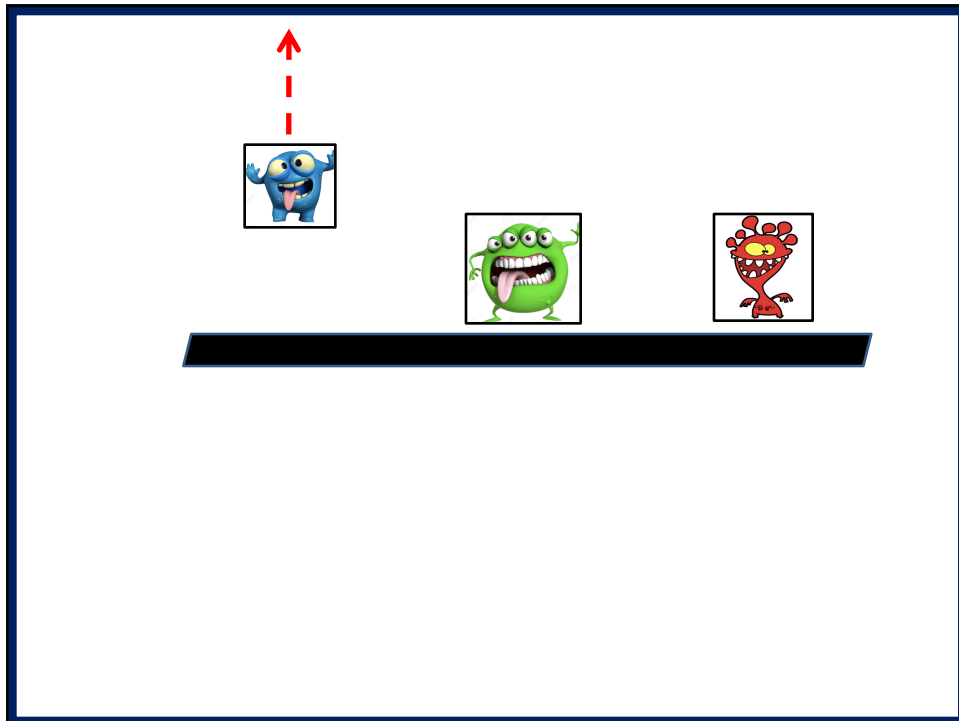
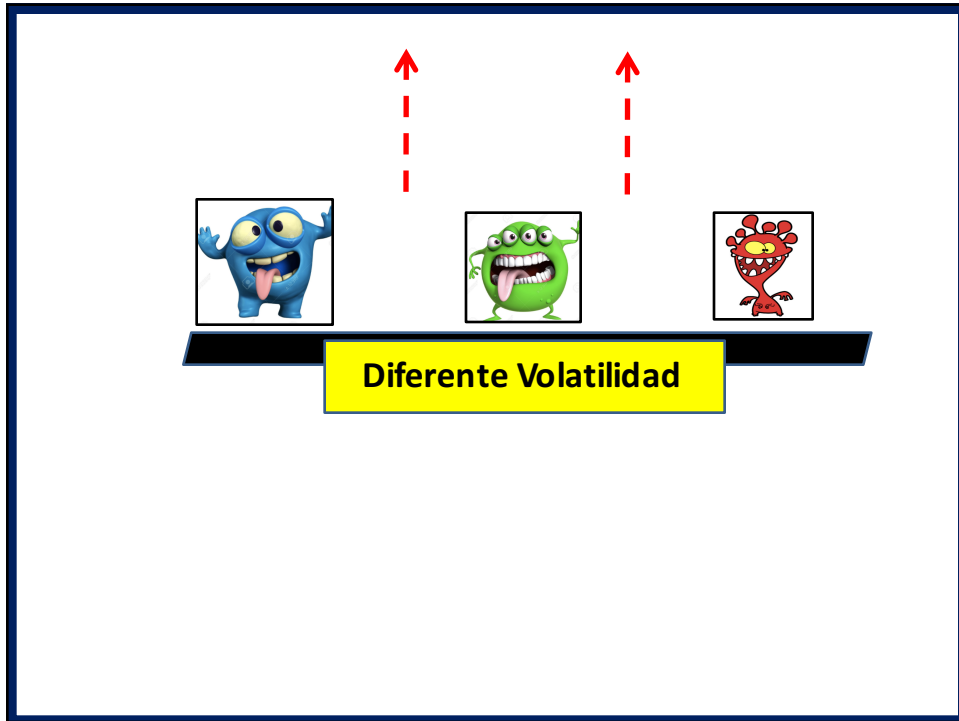

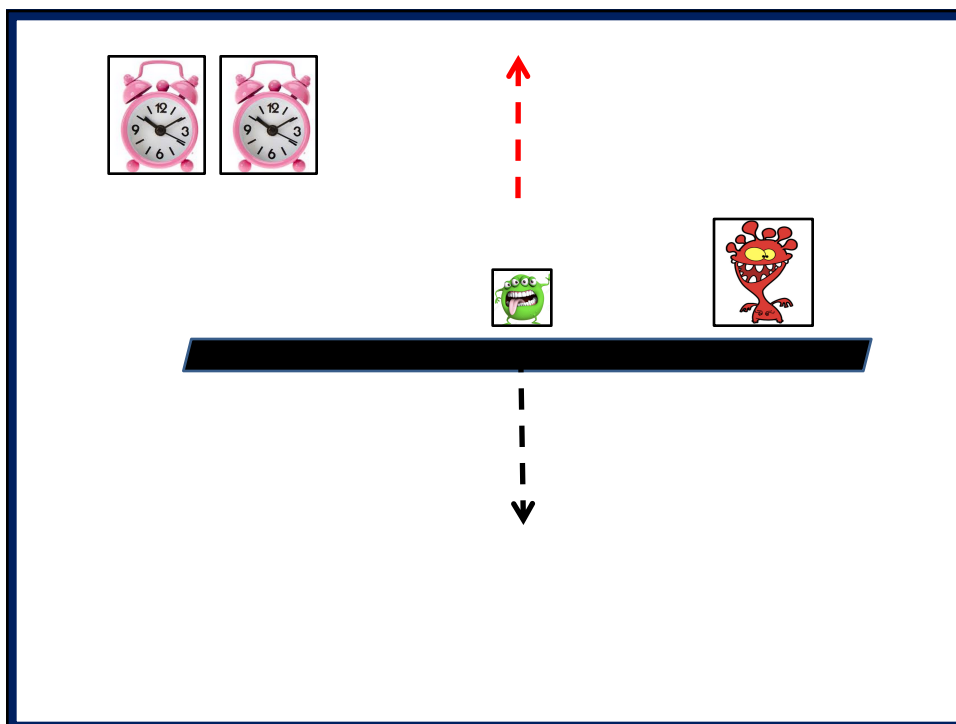
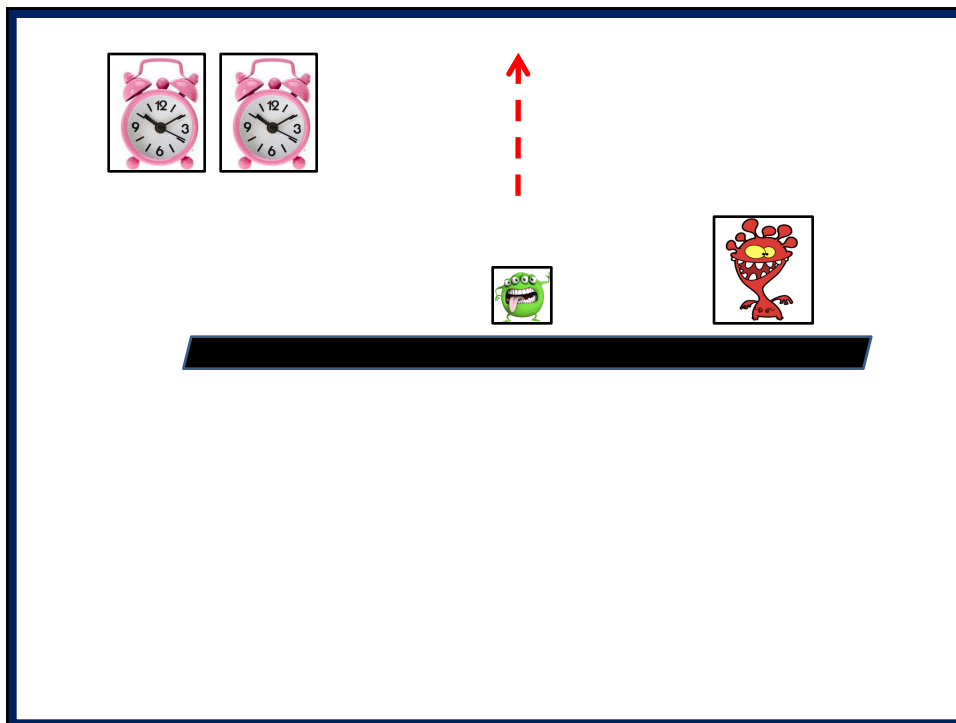

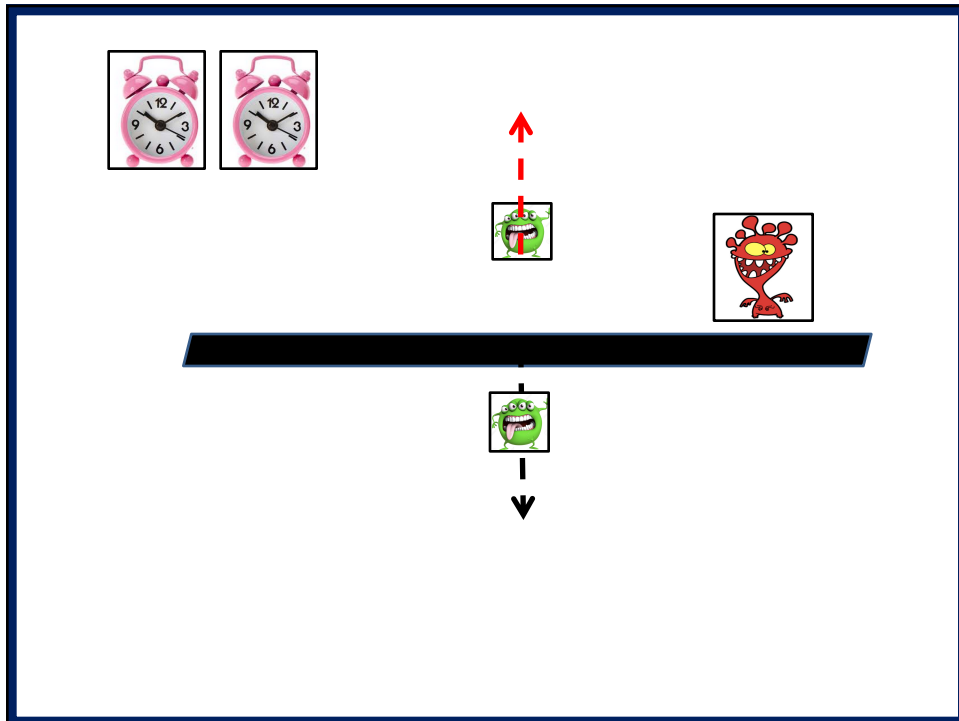
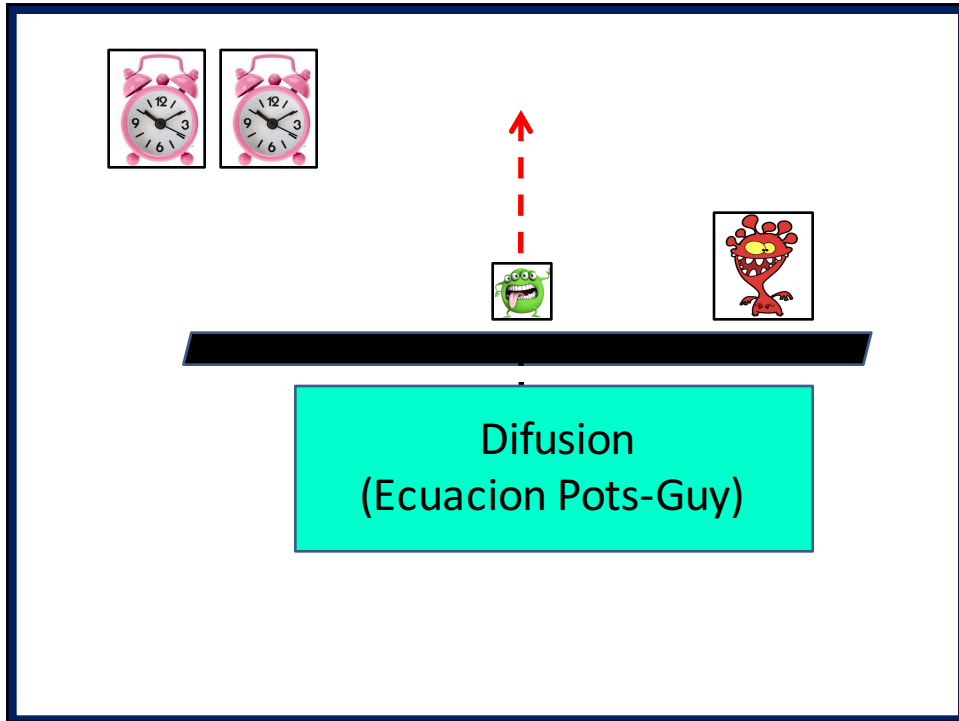

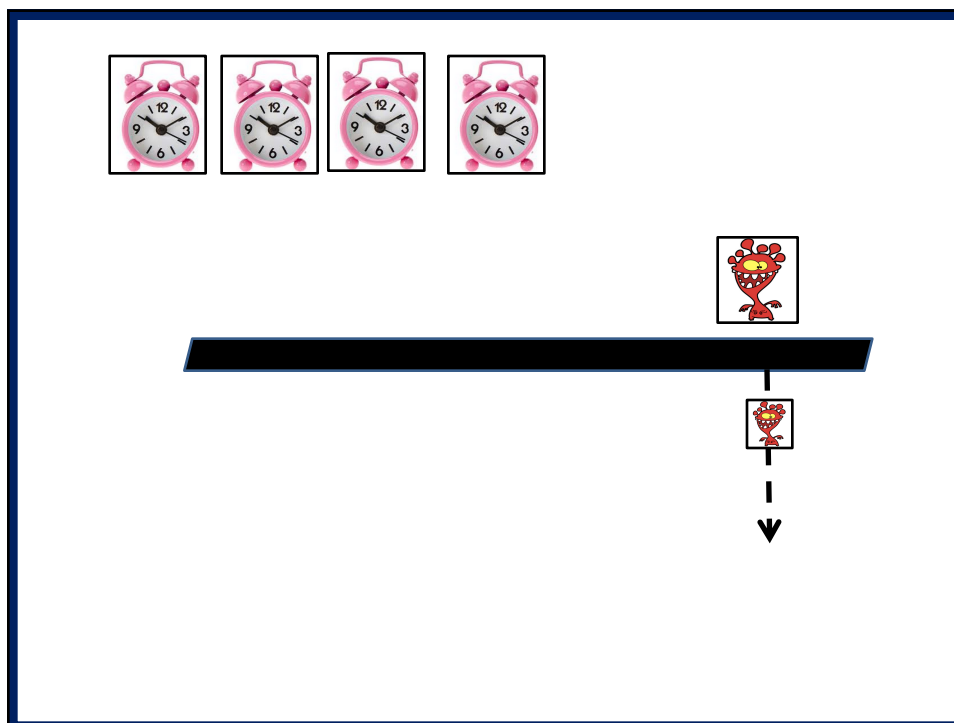





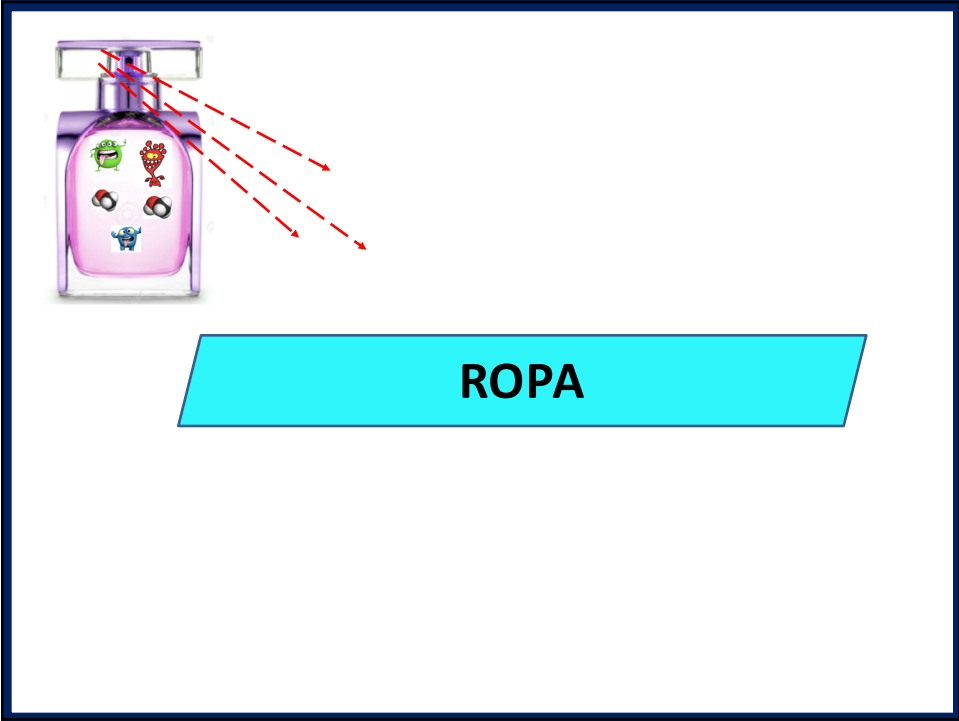
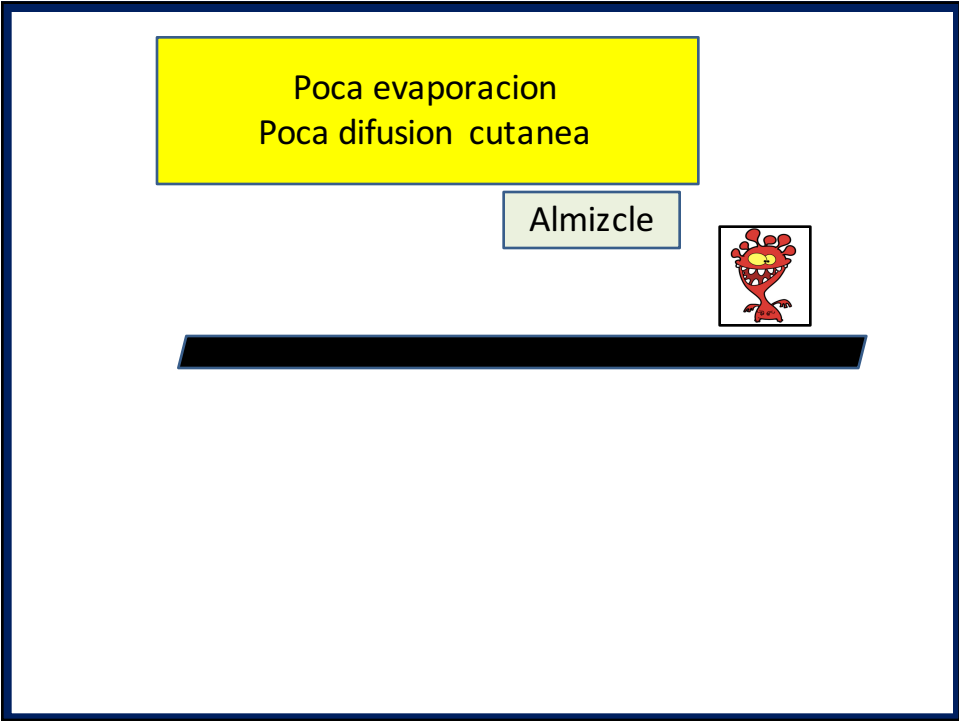

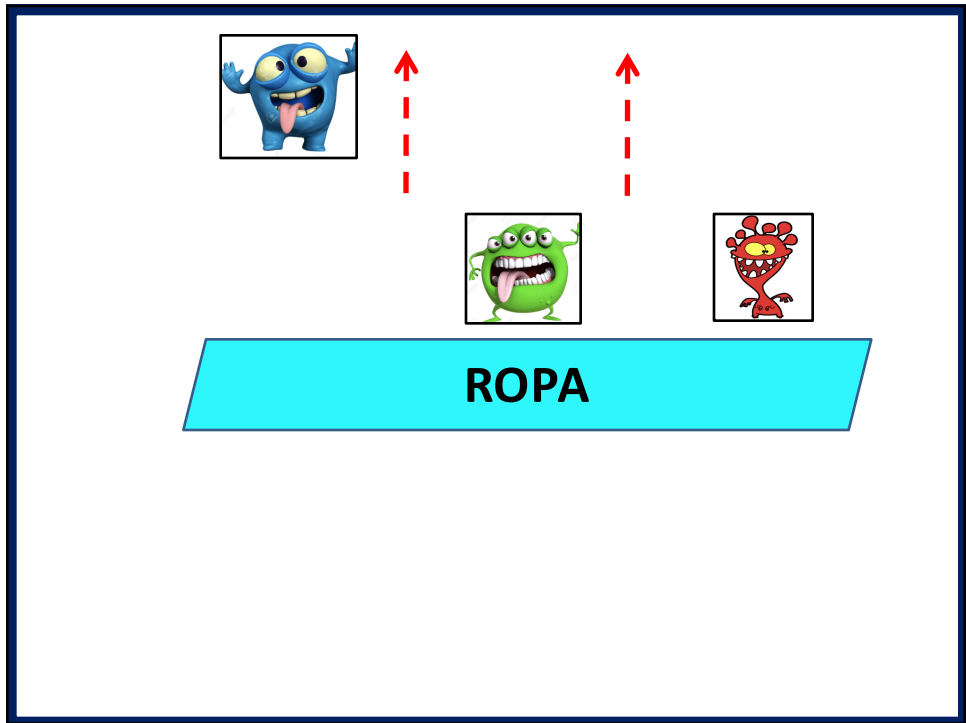
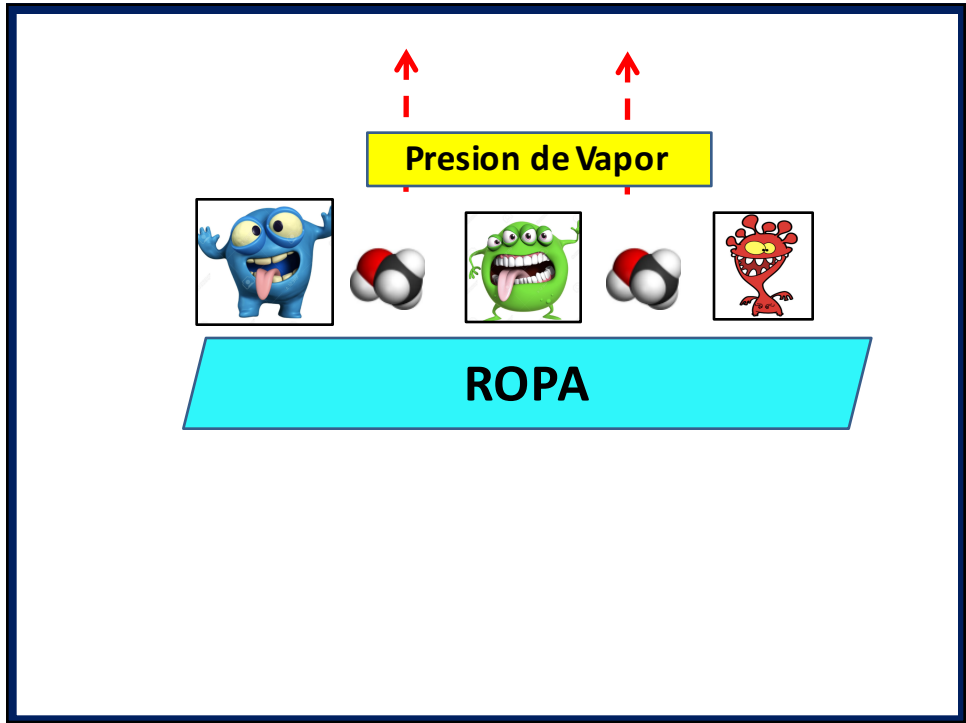
Chemical	MW	log P	J_{max} ($\mu\text{g}/\text{cm}^2/\text{h}$)	
Almizcle 	Musk ketone [1]	294.3	3.79 ± 0.40	0.05
	Musk xylene [2]	297.3	3.80 ± 0.29	0.07
	AHTN [3]	258.4	5.19 ± 0.66	0.14
	HHCB [4]	258.4	4.87 ± 0.82	0.24
	TPCA [5]	267.5	3.61 ± 0.26	1.45
	OTNE [6]	234.4	4.02 ± 0.59	1.64
	Diphenyl ether [7]	170.2	4.21	2.37
	Methyl dihydrojasmonate [8]	226.3	2.78 ± 0.32	2.38
	Diethyl phthalate [9]	222.2	2.42	2.70
	Coumarin [10]	146.2	1.33	2.72
	HMPCC [11]	210.3	2.61 ± 0.47	2.96
	MMDHCA [12]	192.2	2.18 ± 0.35	3.15
	2-phenoxyethyl isobutyrate [13]	208.3	2.74 ± 0.20	6.16
	Methyl eugenol [14]	178.2	2.74 ± 0.26	7.01
	Estragole [15]	148.2	3.08 ± 0.30	13.41
	Benzyl acetate [16]	150.2	1.96	16.68
	Methyl atratate [17]	196.2	2.30 ± 0.46	17.31
	Linalool [18]	154.3	2.97	31.04
Limoneno 	Phenylethyl alcohol [19]	122.2	1.36	43.91
	d-limonene [20]	136.2	4.57	47.13

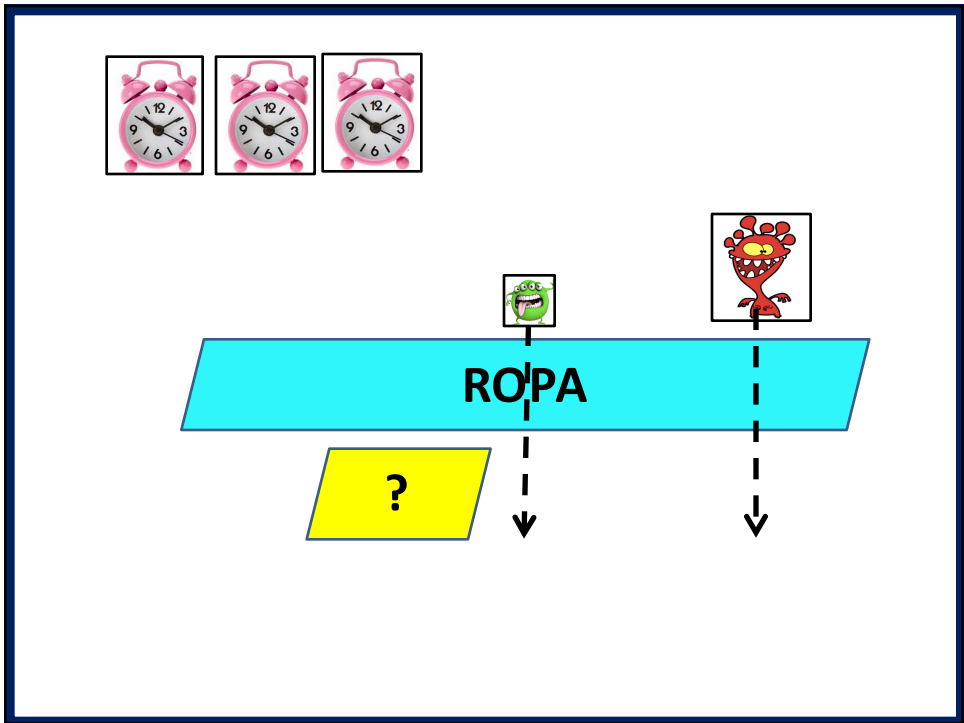
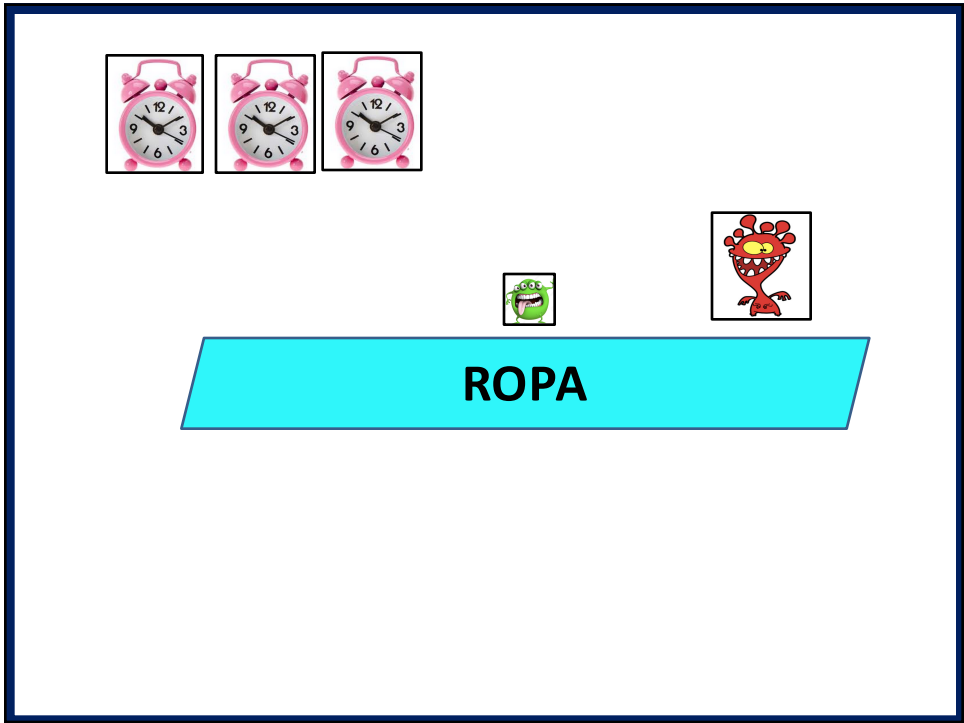











ROPA



PIEL



ROPA

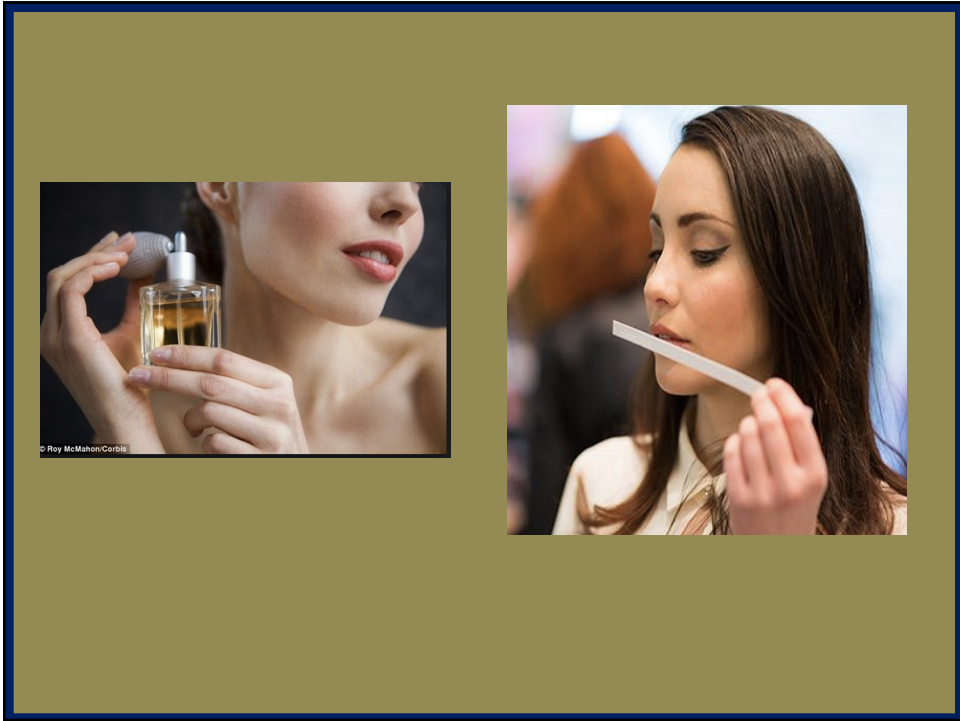

**Misma Fragancia
Gel de Ducha**

A hand is shown holding a purple shower gel bottle with a yellow band. To the right of the bottle are three cartoon monster icons: a blue one with its tongue out, a green one with its tongue out, and a red one with a wide, toothy grin.

Tensoactivos

INGREDIENTS: Aqua , Sodium Lauryl Sulfate, Sodium Laureth Sulfate, Cocamidopropyl Betaine, Sodium Chloride, Sodium Citrate, Citric Acid, Sodium



Laureth Sulfato

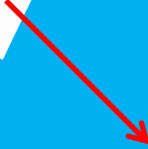

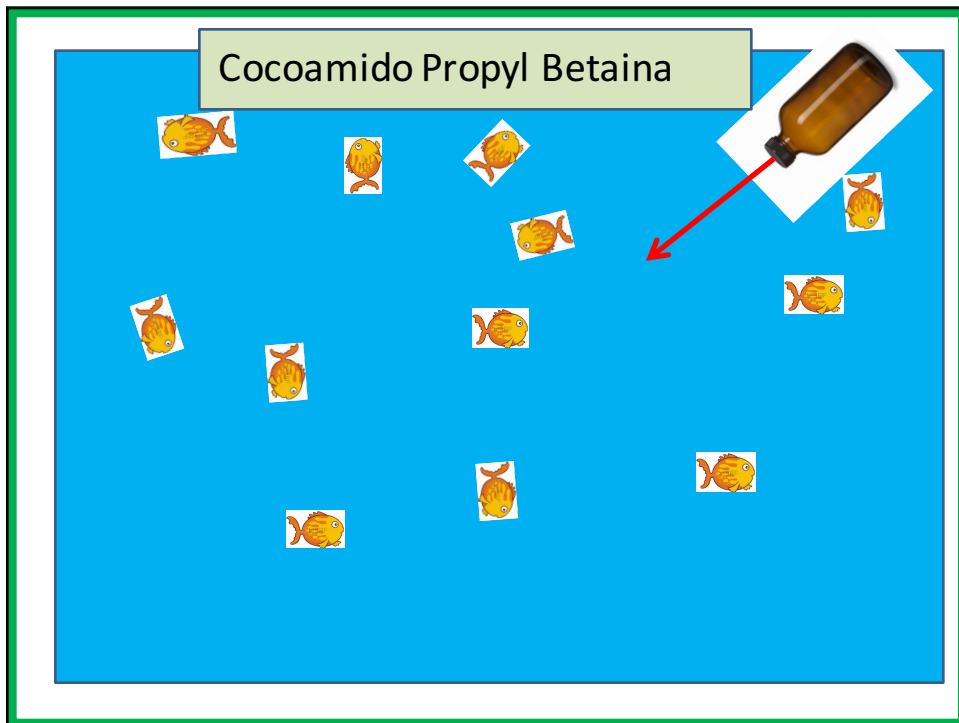
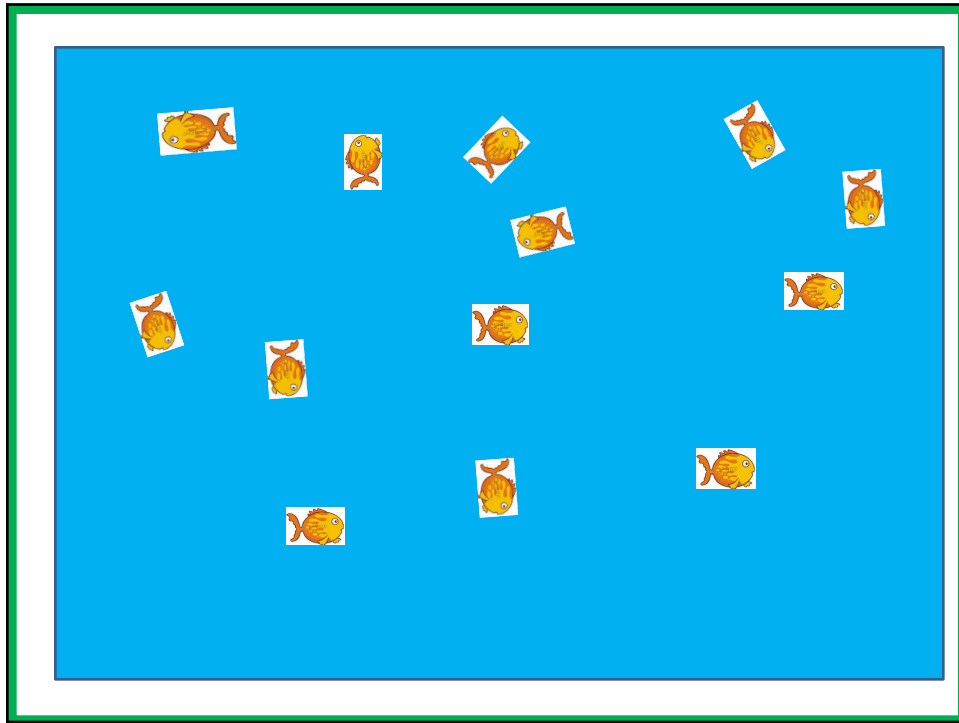

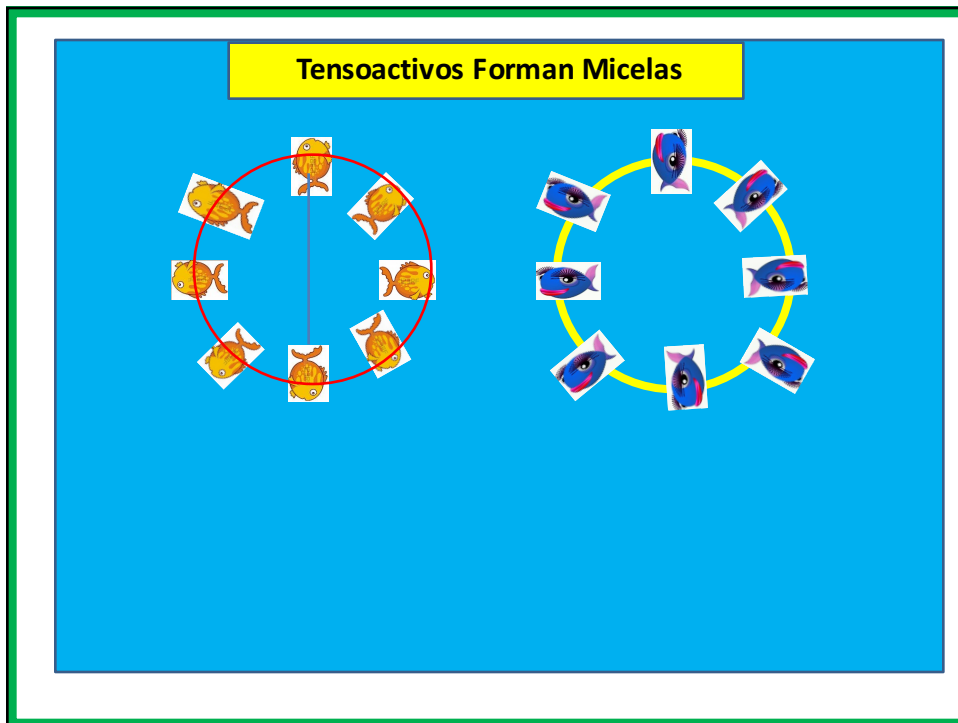
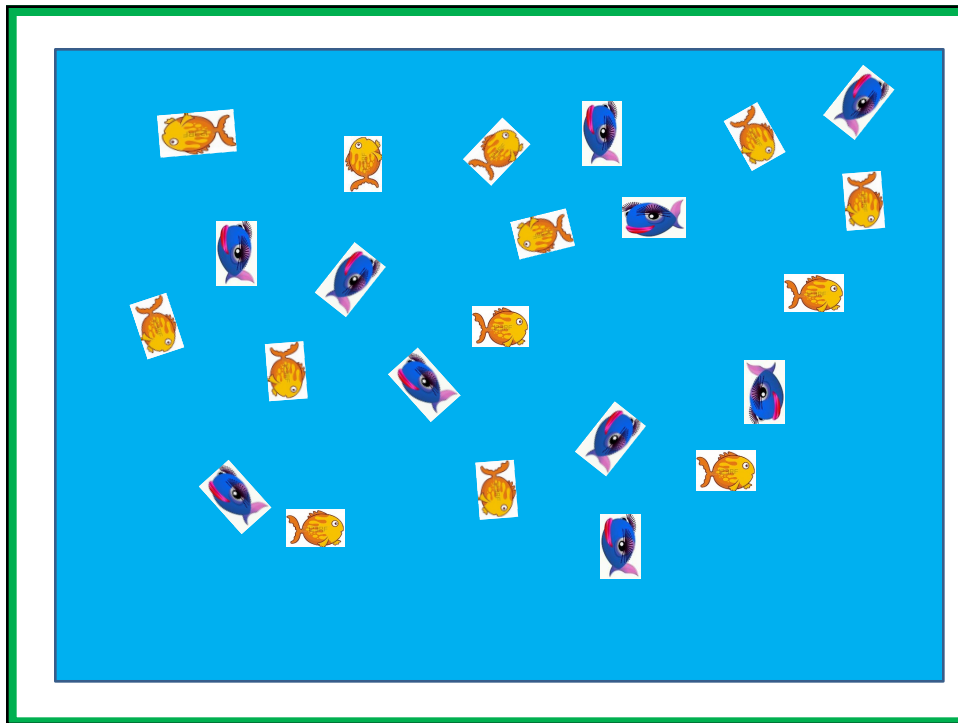

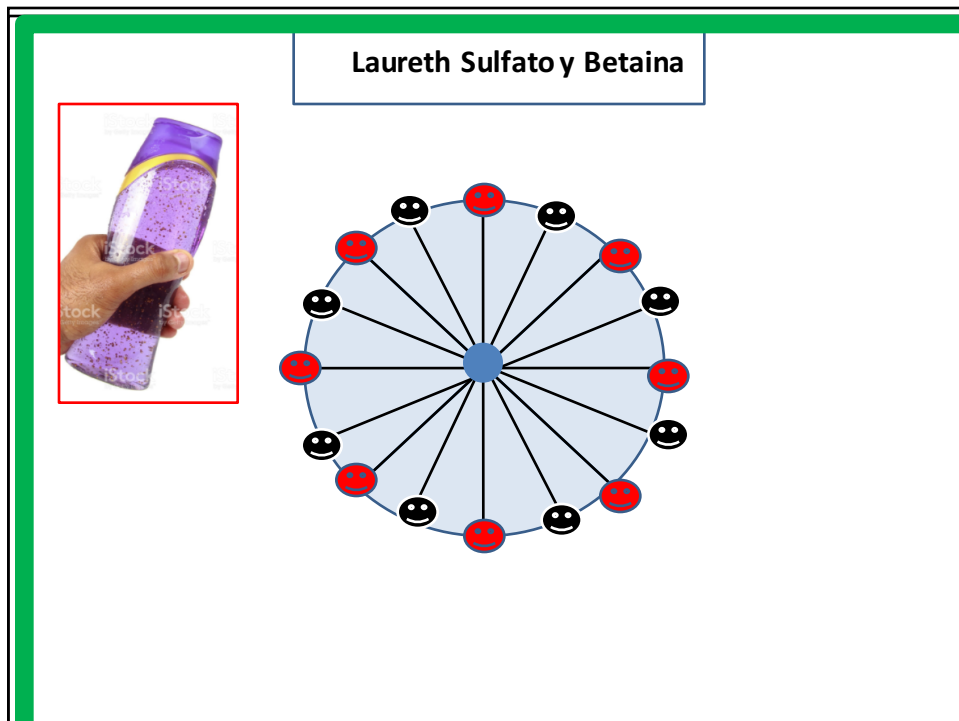
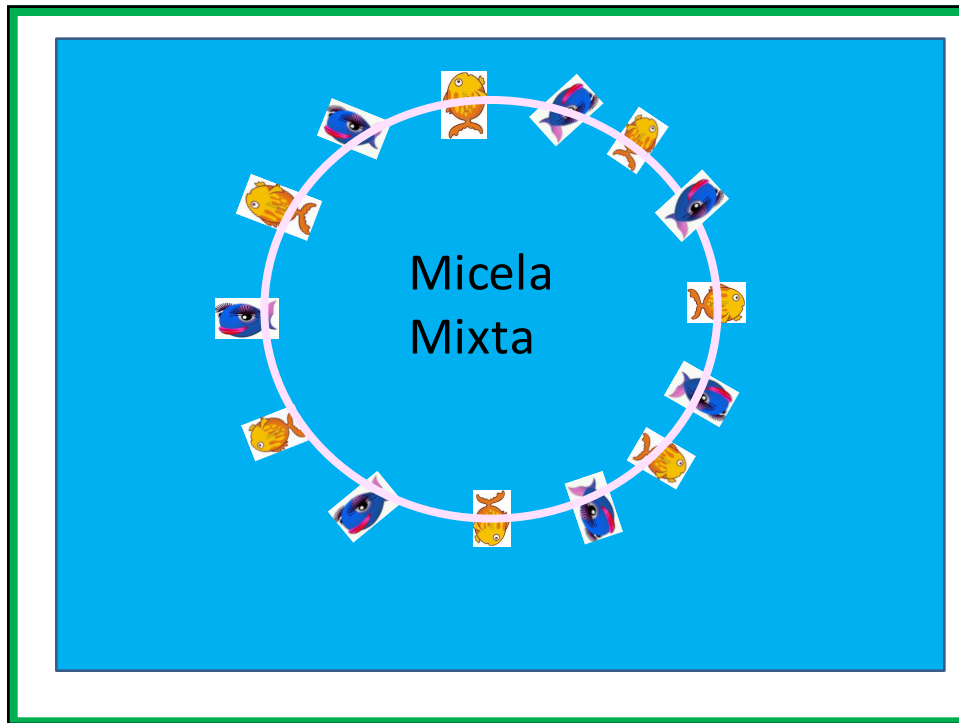

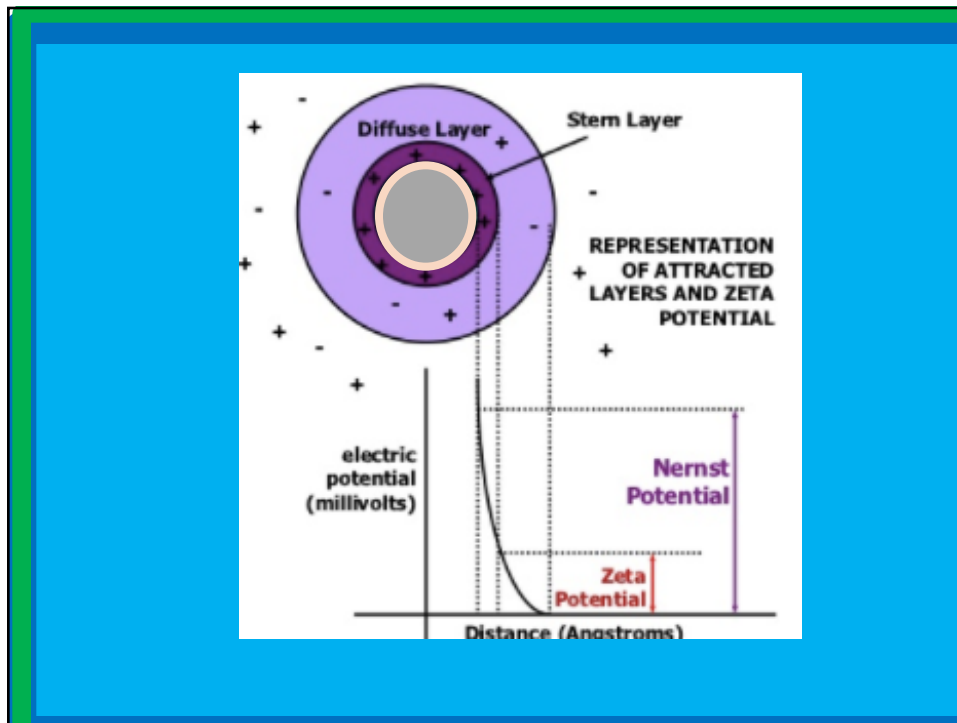
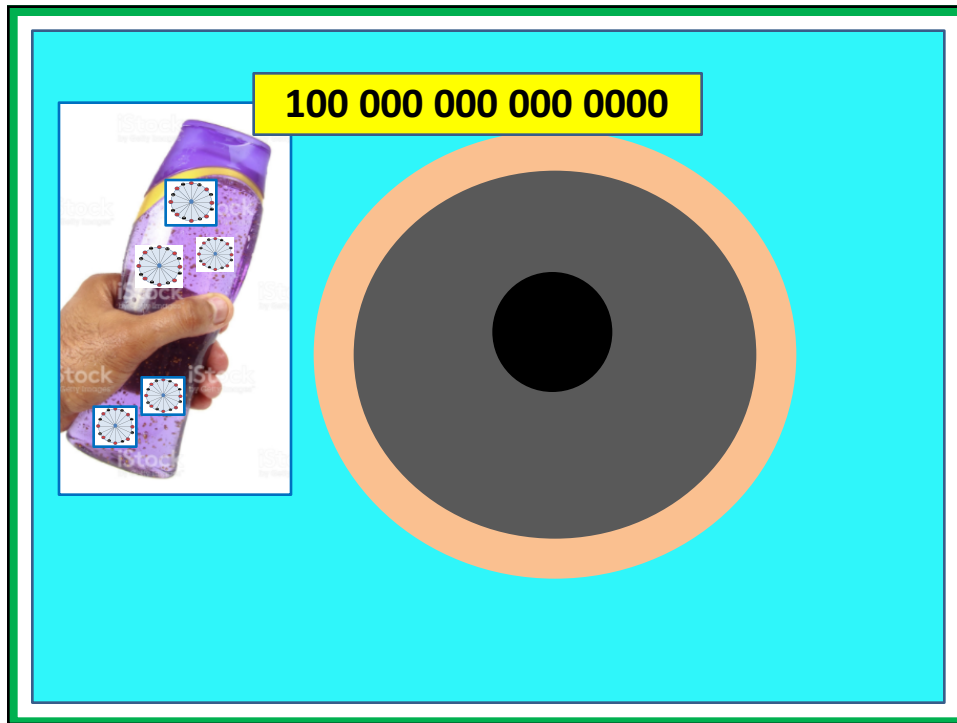

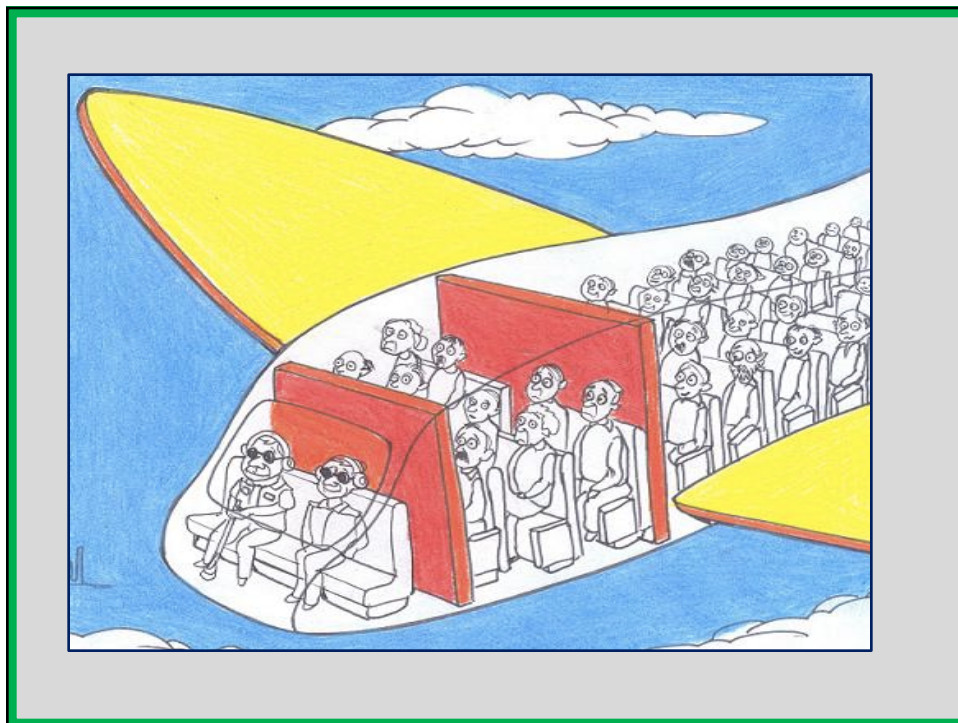
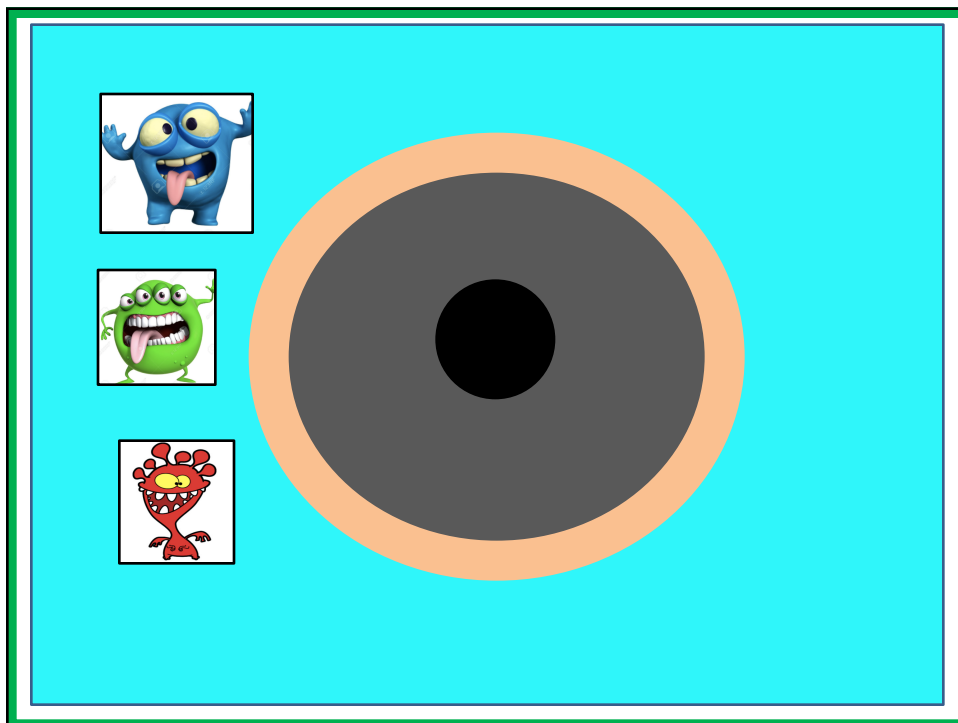

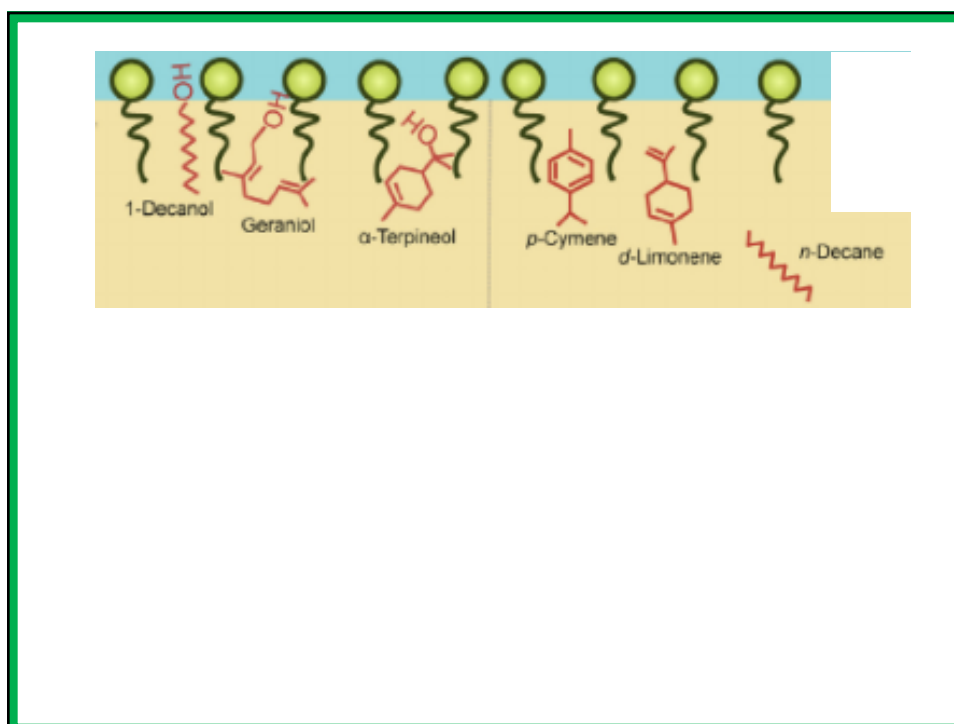
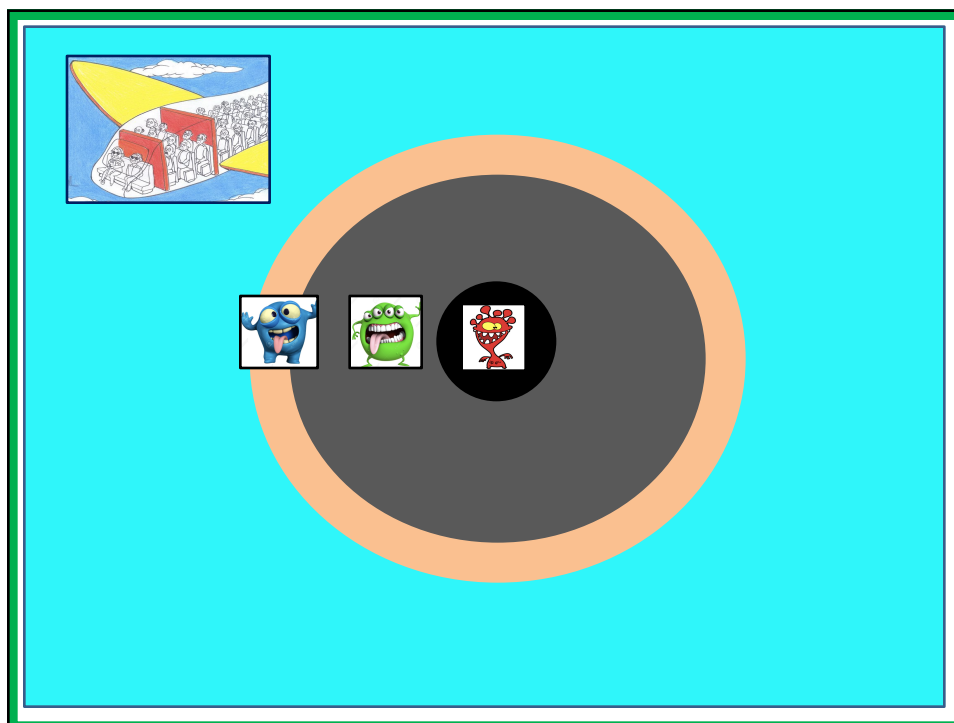

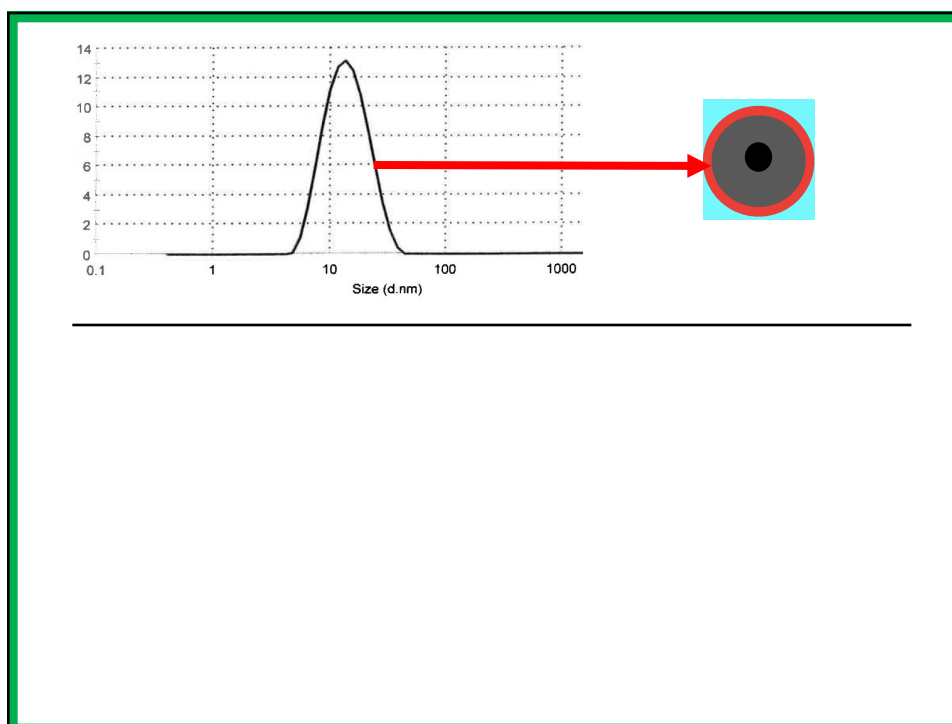
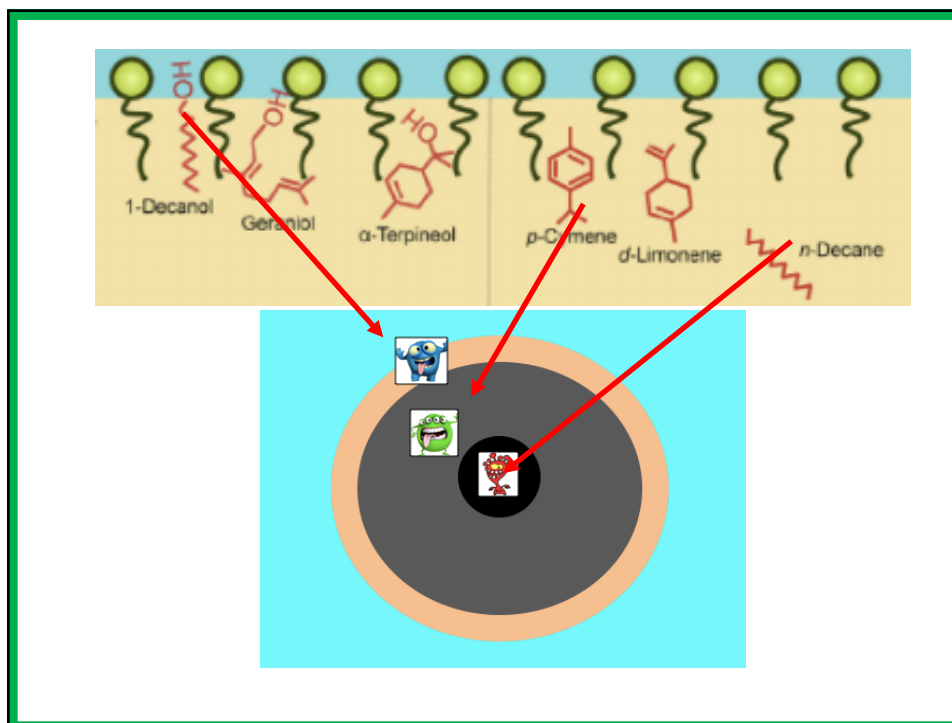

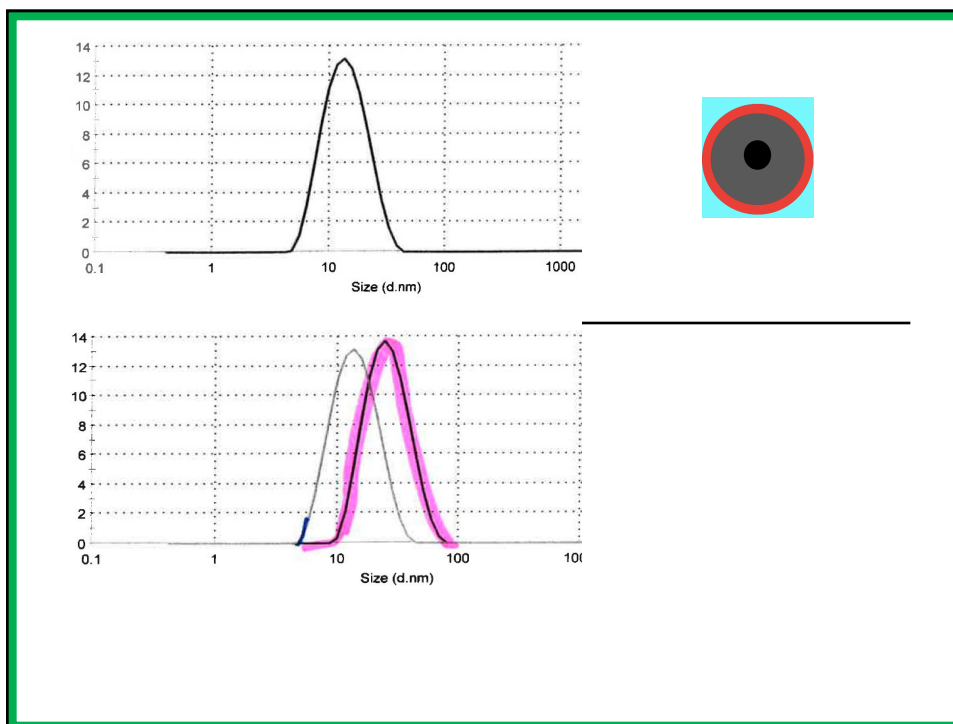
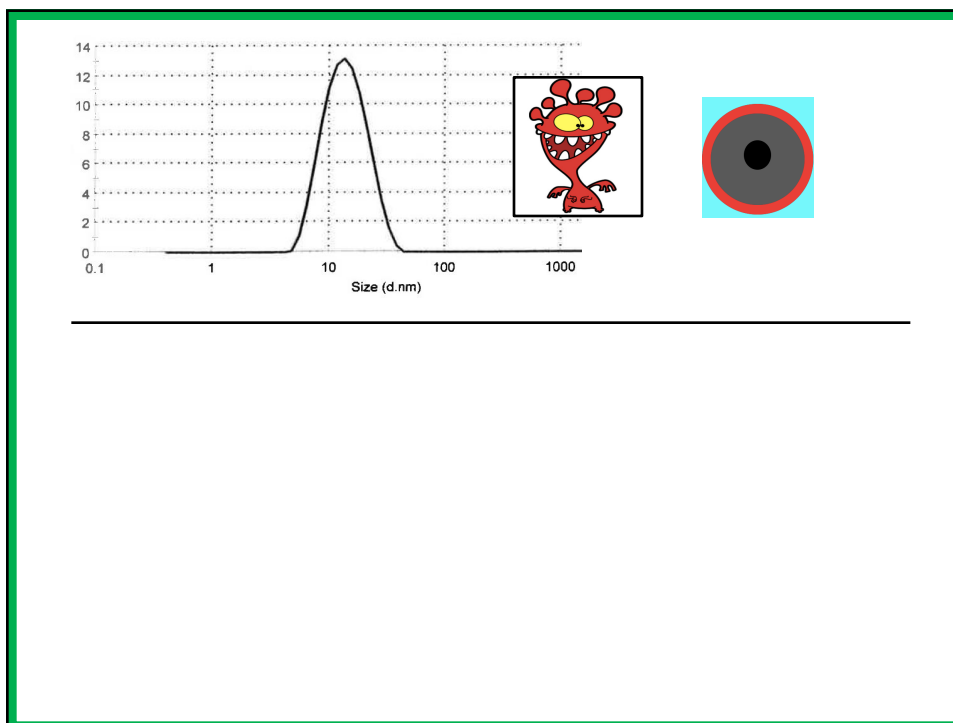

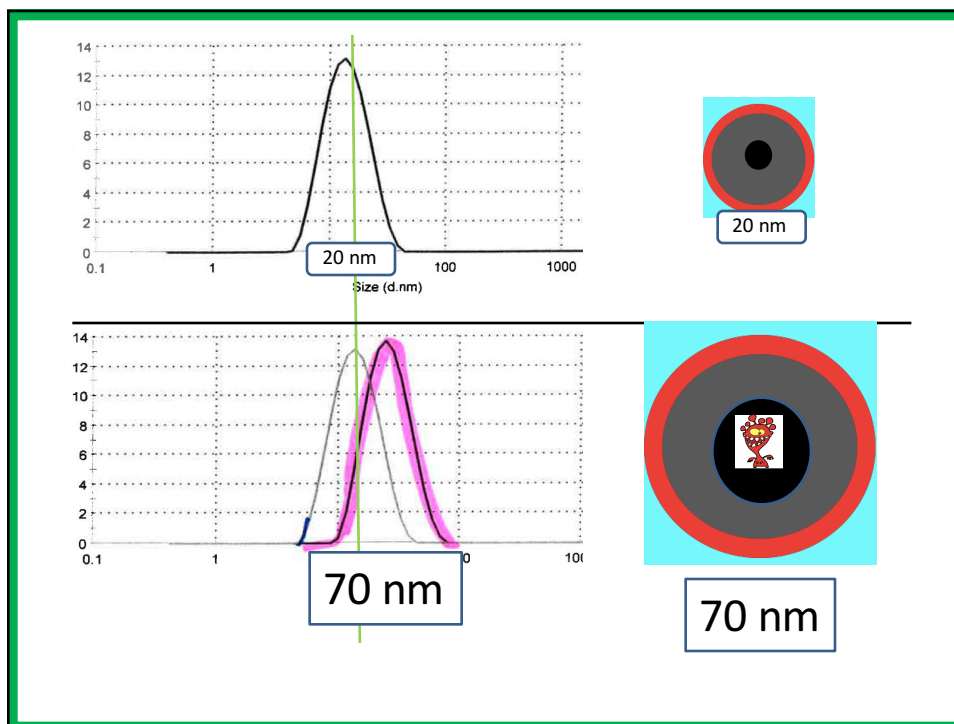
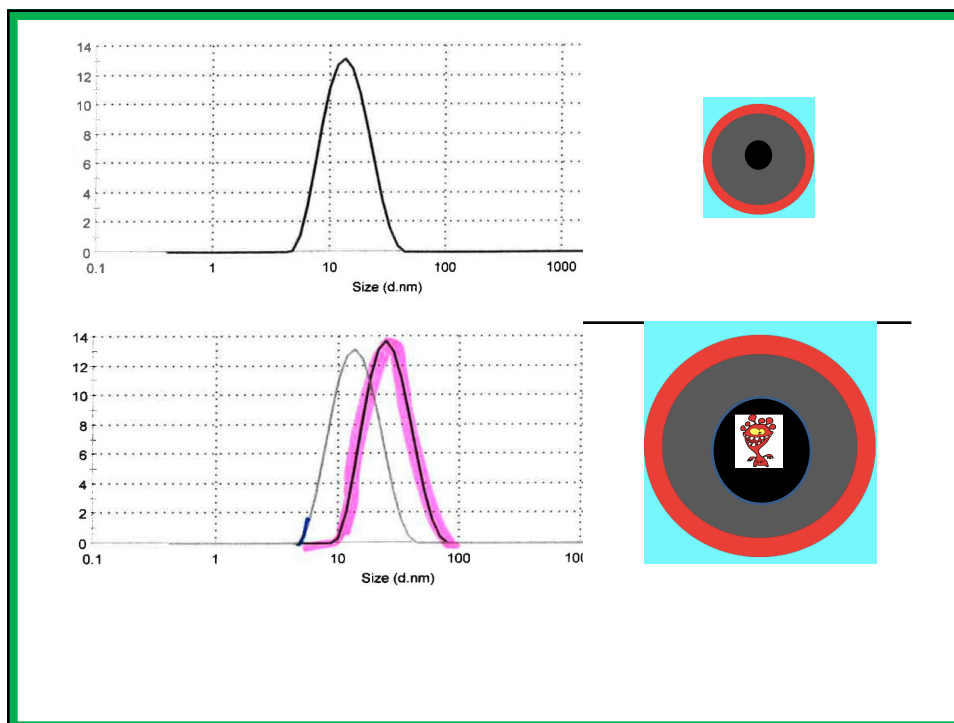

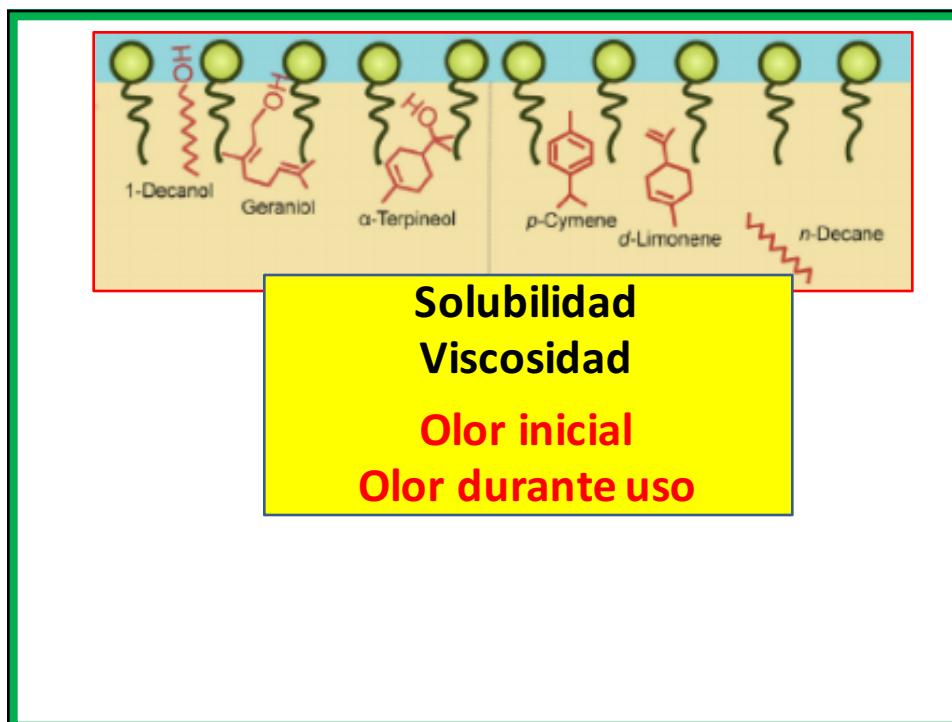
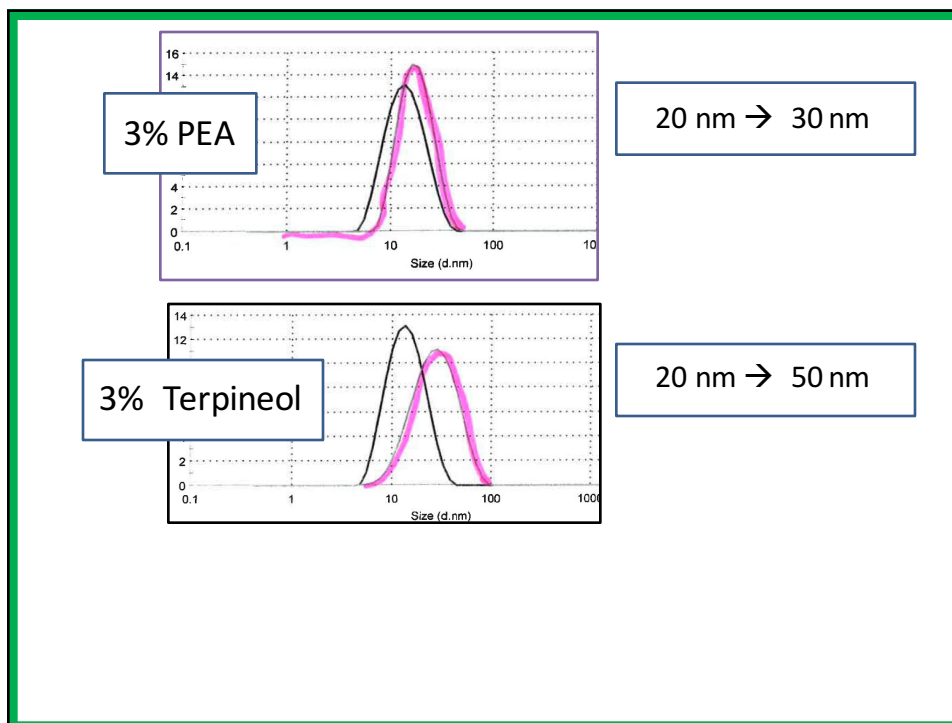



100 000 000 000 000

Primer Impacto de la Fragancia

The diagram consists of a large light blue circle with a dark grey center. Three small icons are placed within the circle: a blue character at the top, a green character on the left, and a trophy at the bottom.

Primer Impacto de la Fragancia



The image shows a hand holding a purple perfume bottle on the left. A red box highlights the top of the bottle. On the right, a profile of a nose is shown with a white soundwave graphic emanating from it, symbolizing the initial impact of the fragrance.

Primer Impacto de la Fragancia

Cantidad relativa de moléculas "soltadas"



The diagram consists of a central black circle containing three icons: a blue monster, a green monster, and a trophy. This central circle is surrounded by a larger orange circle, all set against a light blue background. This represents the relative quantity of molecules released from the fragrance.

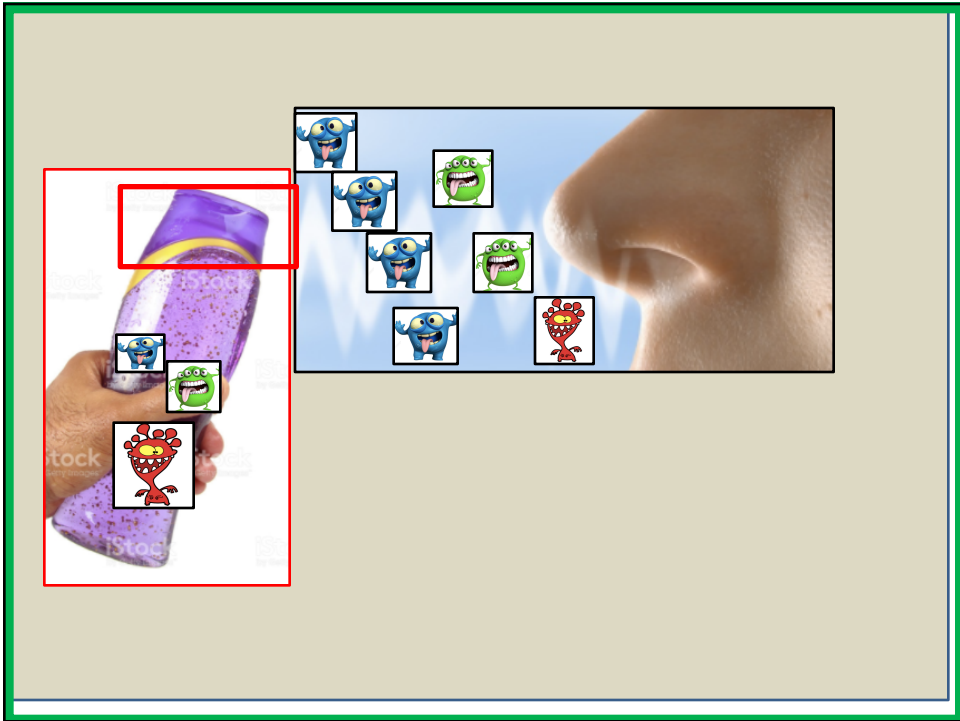
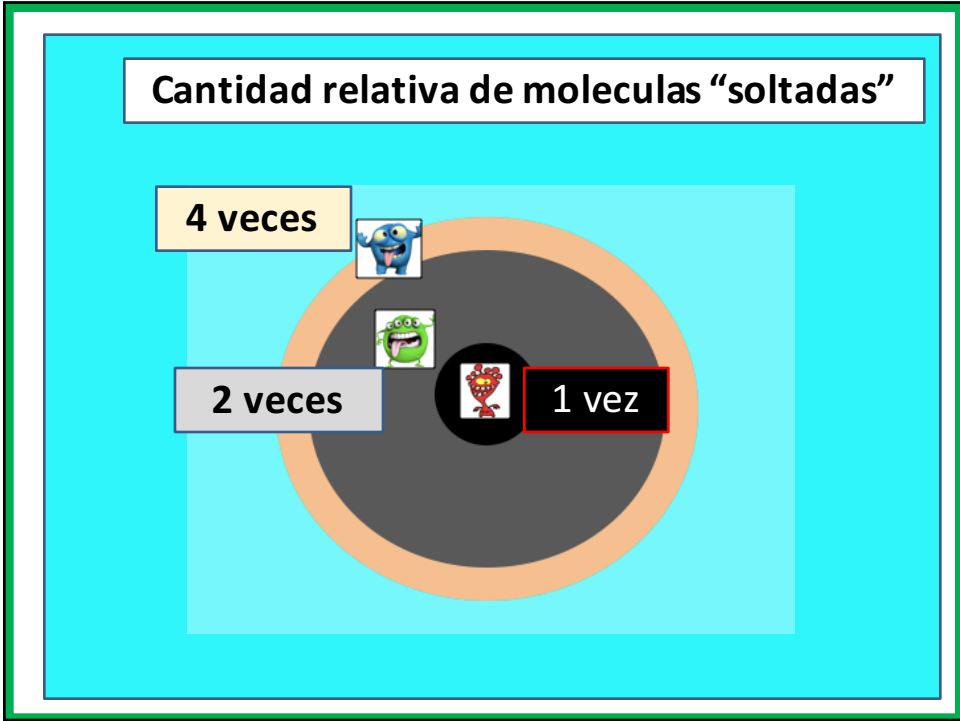

% Head Space by GC

Fragrance component	"Sola"
Limonene	31.9
Linalool	13.2
Linalyl acetate	12.3
PEA	6.2
Benzyl acetate	11.6

Huele la fragancia igual ...?



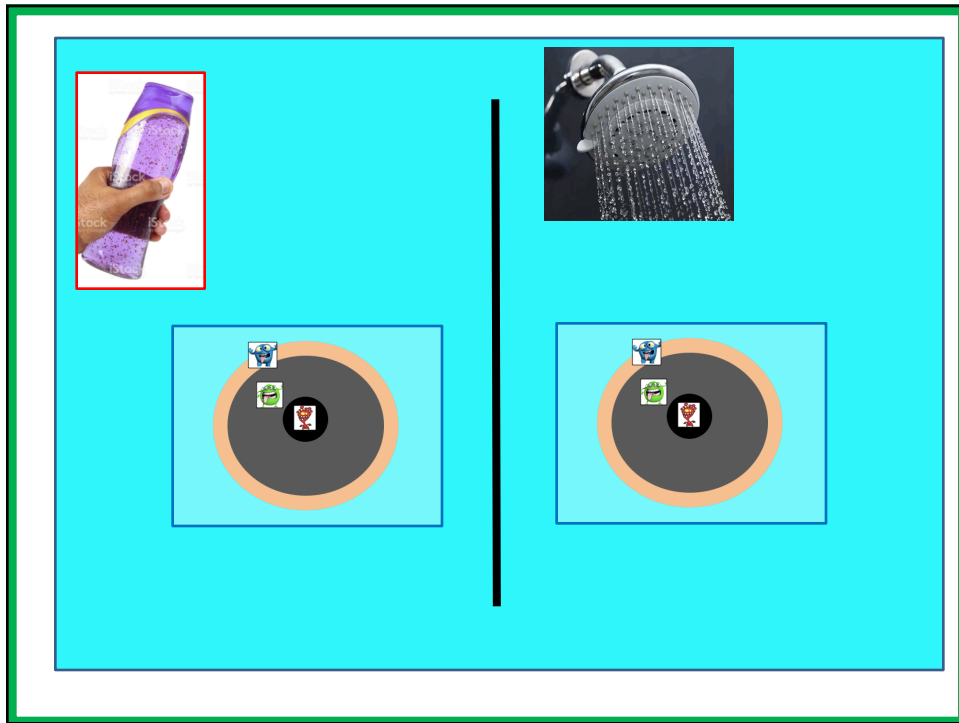
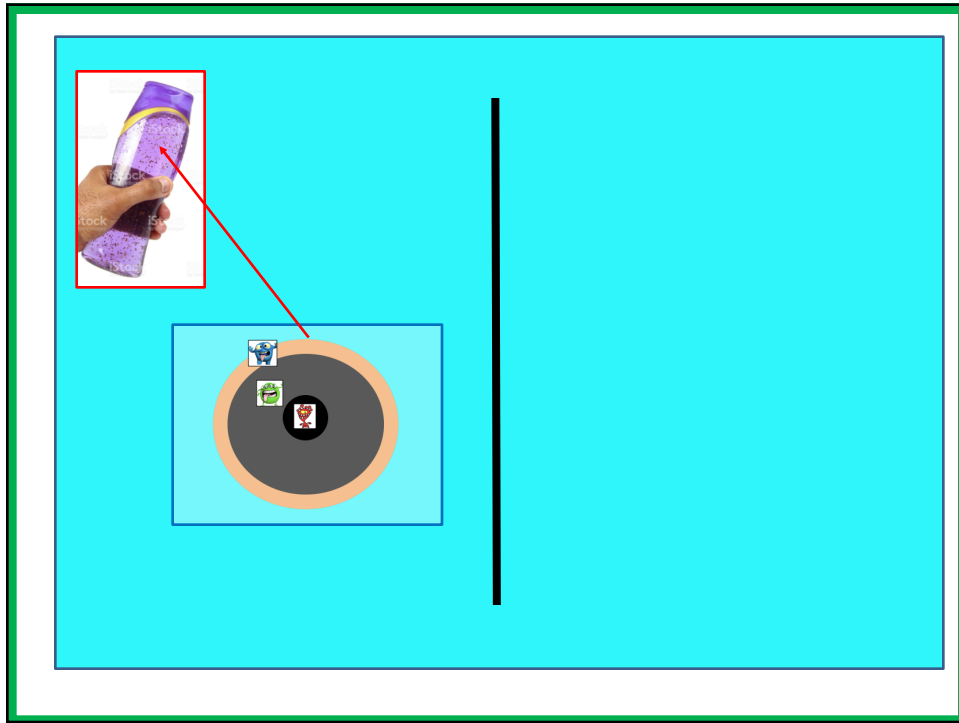

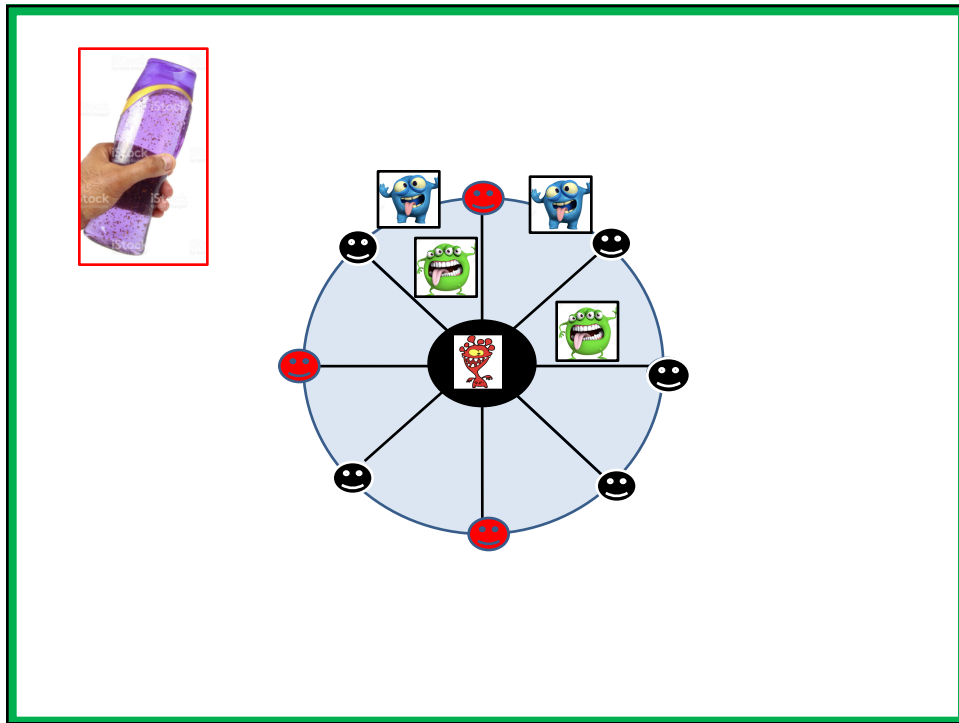
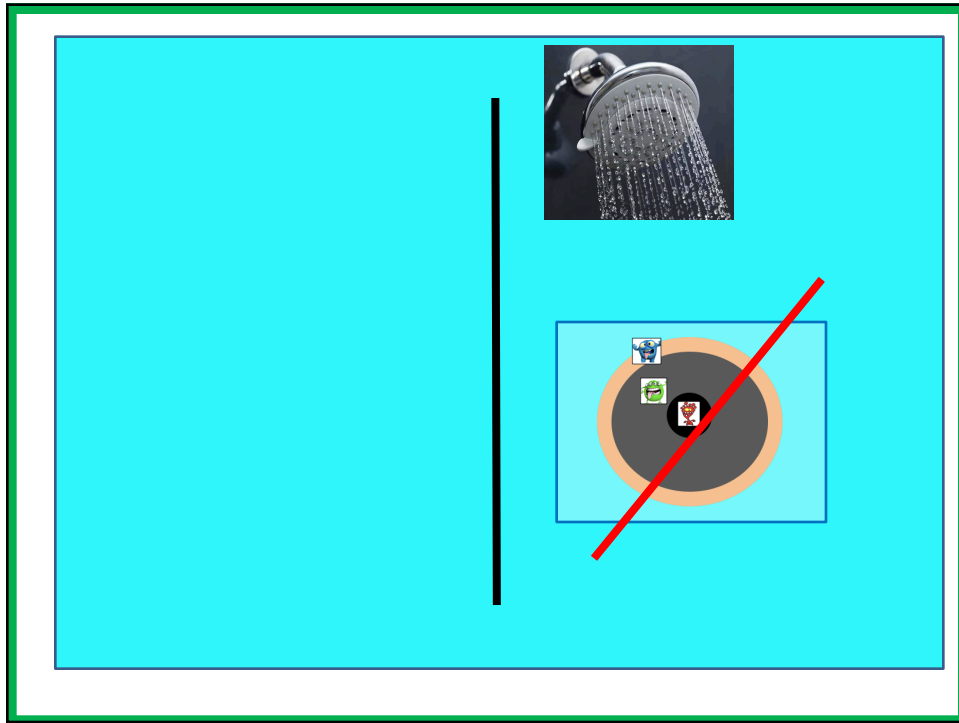

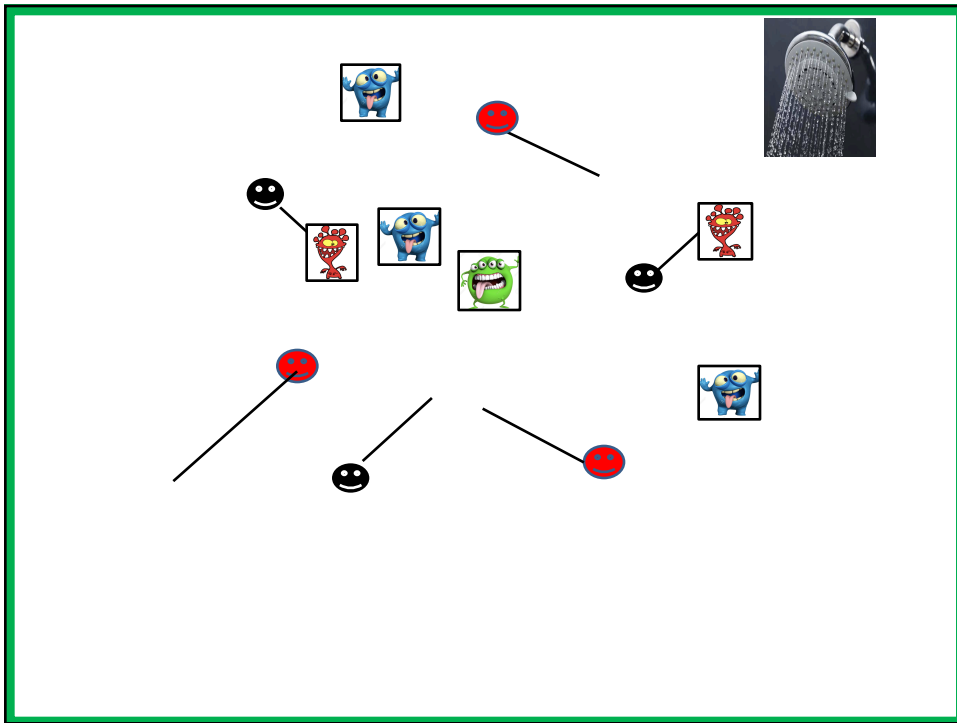
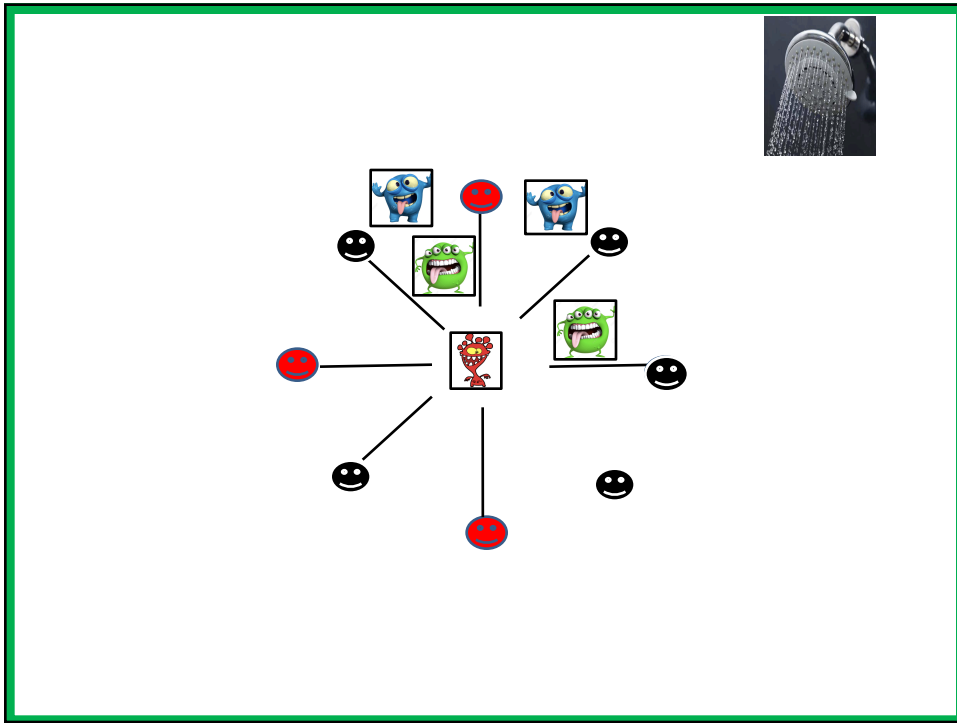

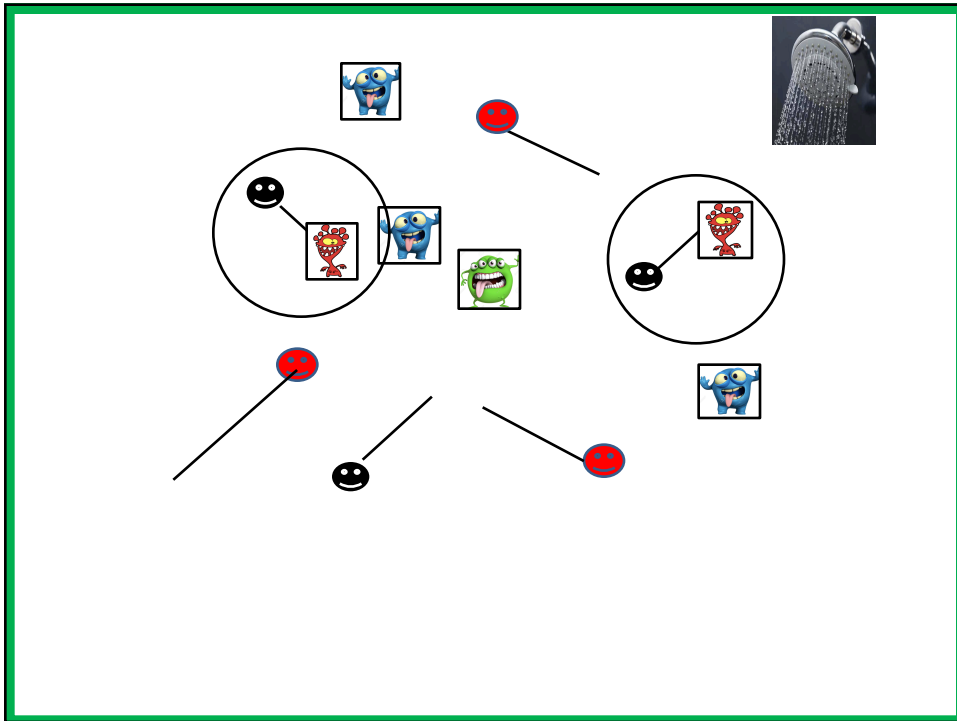

Las cosas cambian ahora...

$$PBI = \frac{\phi - 1.4/CMC}{K}$$

ϕ =oil/water partition coefficient of selected perfume or perfume components of a mixture;

CMC=critical micellization concentration (wt/wt) of surfactant system;

K=volatility constant of perfume or perfume components of the mixture from the continuous phase

$$PBI = \frac{\phi - 1.4/CMC}{K}$$

ϕ =oil/water partition coefficient of selected perfume or perfume components of a mixture;

CMC=critical micellization concentration (wt/wt) of surfactant system;

K=volatility constant of perfume or perfume components of the mixture from the continuous phase

Volatilidad del perfume
Solubilidad en agua
Tipo de formulacion

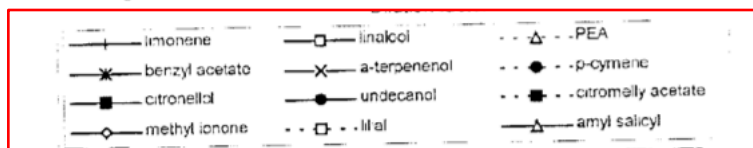
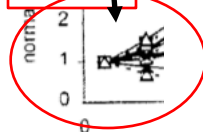
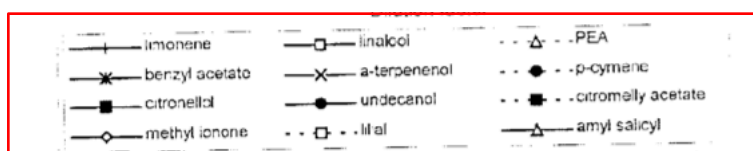

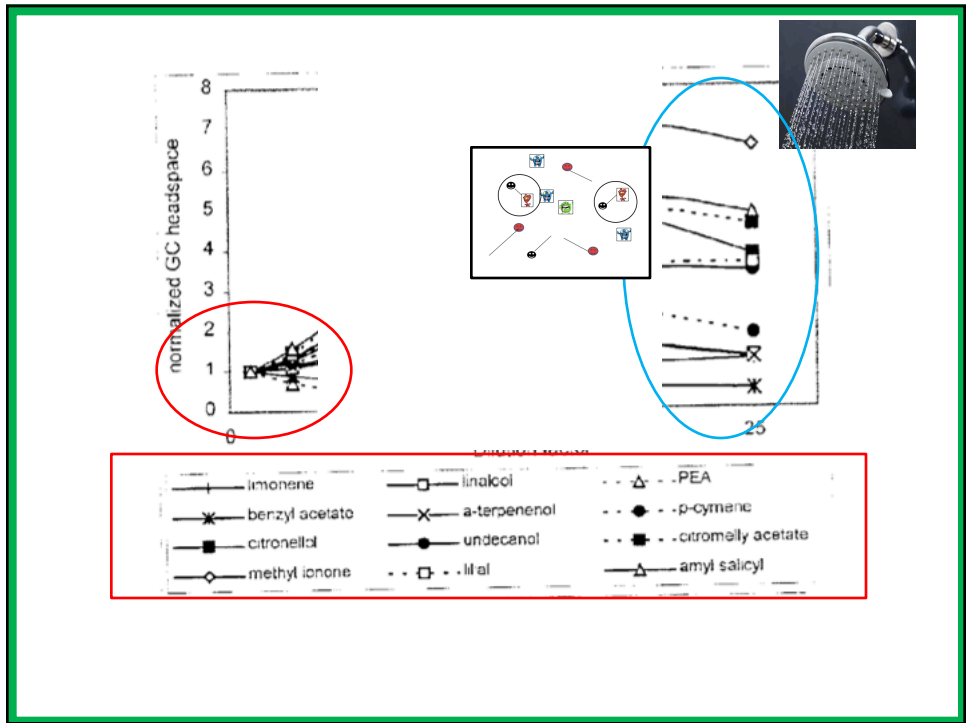
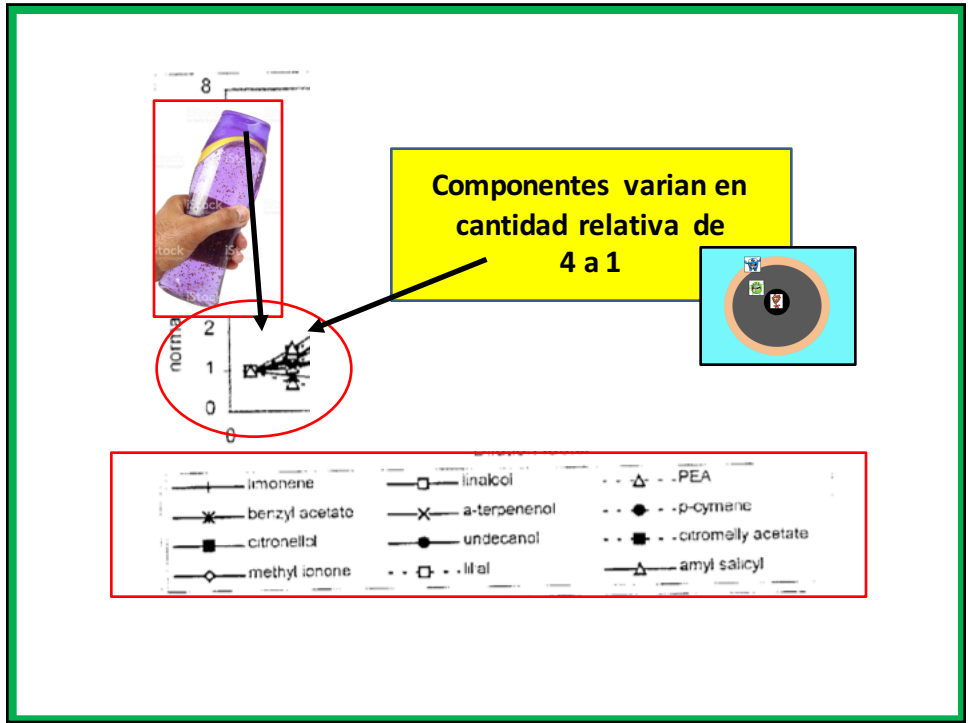

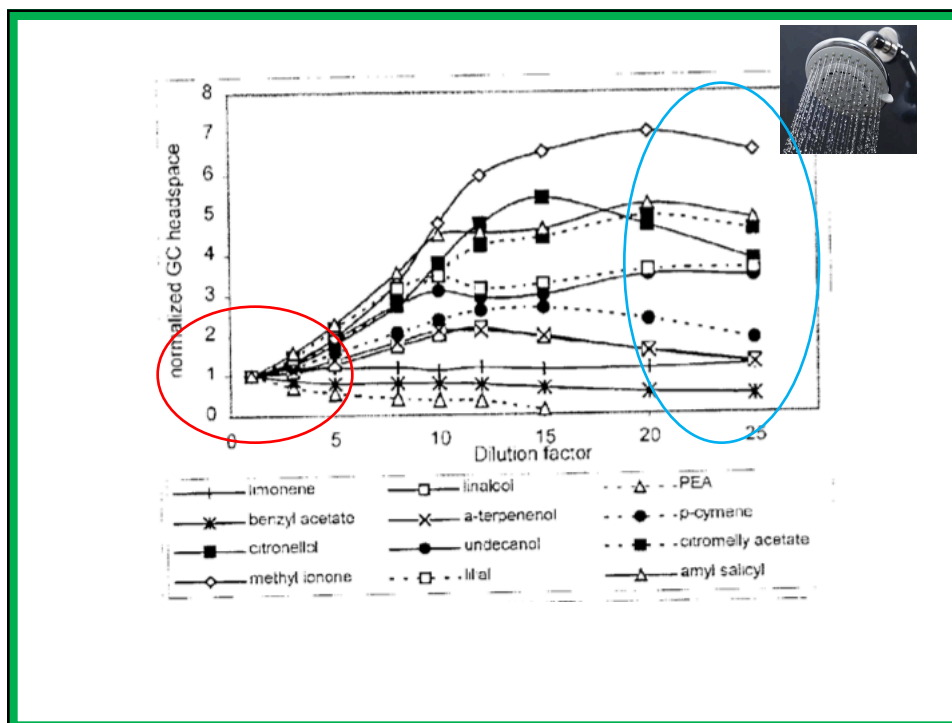

TABLE 3

PBI Values for Various Perfumes

Perfume Molecule	PBI	"20% Burst"?
Acetanisol	-31,000	No
p-Cresol	-27,778	No
Indole	-5,209	No
Benzyl Acetate	-819	No
2-Phenoxyethanol	-156	No
2-heptanone	-153	No
Acetaldehyde	-130	No
Cinnamyl Acetate	-122	No
Hexanal	-109	No
Methyl Benzoate	-13	No
Anisole	-5	No
Limonene	12	Yes
p-Cymene	12.2	Yes
α-pinene	20	Yes
Isoeugenol	58	Yes
Menthone	61	Yes
Naphthalene	107	Yes
2-Nonanone	180	Yes
Tetrahydrolinalool	202	Yes
Linalool	240	Yes
Dihydromyrcenol	307	Yes
Nonanal	502	Yes
Ethyl Undecylenate	624	Yes
Decanal	942	Yes
α-ionone	1,692	Yes
γ-methyl ionone	1,677	Yes
1-nonanol	24,164	Yes
Methyl Linolenate	771,304	Yes
Methyl Linoleate	61149428	Yes





JABON**TABLE 3****PBI Values for Various Perfumes**

Perfume Molecule	PBI	"20% Bust"?
Acetanisol	-31,000	No
p-Cresol	-27,778	No
Indole	-5,209	No
Benzyl Acetate	-819	No
2-Phenoxyethanol	-156	No
2-heptanone	-153	No
Acetaldehyde	-130	No
Cinnamyl Acetate	-122	No
Hexanal	-109	No
Methyl Benzoate	-13	No
Anisole	-5	No
Limonene	12	Yes
p-Cymene	12.2	Yes
α-pinene	20	Yes
Isoeugenol	58	Yes
Menthone	61	Yes
Naphthalene	107	Yes
2-Nonanone	180	Yes
Tetrahydrolinolool	202	Yes
Linalool	240	Yes
Dihydromyrcenol	307	Yes
Nonanal	502	Yes
Ethyl Undecylenate	624	Yes
Decanal	942	Yes
α-ionone	1,692	Yes
γ-methyl ionone	1,677	Yes
1-nonanol	24,164	Yes
Methyl Linolenate	771,304	Yes
Methyl Linoleate	61149428	Yes

JABON**Eter Sulfato – Betaina ?**

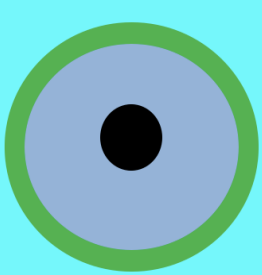
Perfume Molecule	PBI	"20% Bust"?
Acetanisol	-31,000	No
p-Cresol	-27,778	No
Indole	-5,209	No
Benzyl Acetate	-819	No
2-Phenoxyethanol	-156	No
2-heptanone	-153	No
Acetaldehyde	-130	No
Cinnamyl Acetate	-122	No
Hexanal	-109	No
Methyl Benzoate	-13	No
Anisole	-5	No
Limonene	12	Yes
p-Cymene	12.2	Yes
α-pinene	20	Yes
Isoeugenol	58	Yes
Menthone	61	Yes
Naphthalene	107	Yes
2-Nonanone	180	Yes
Tetrahydrolinolool	202	Yes
Linalool	240	Yes
Dihydromyrcenol	307	Yes
Nonanal	502	Yes
Ethyl Undecylenate	624	Yes
Decanal	942	Yes
α-ionone	1,692	Yes
γ-methyl ionone	1,677	Yes
1-nonanol	24,164	Yes
Methyl Linolenate	771,304	Yes
Methyl Linoleate	61149428	Yes

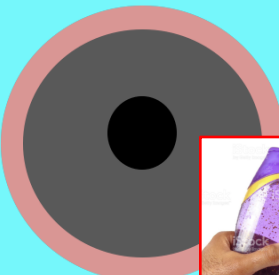

<p>Carboxilato</p>  	<p>Eter Sulfato – Betaina</p>  
---	---

	
---	--

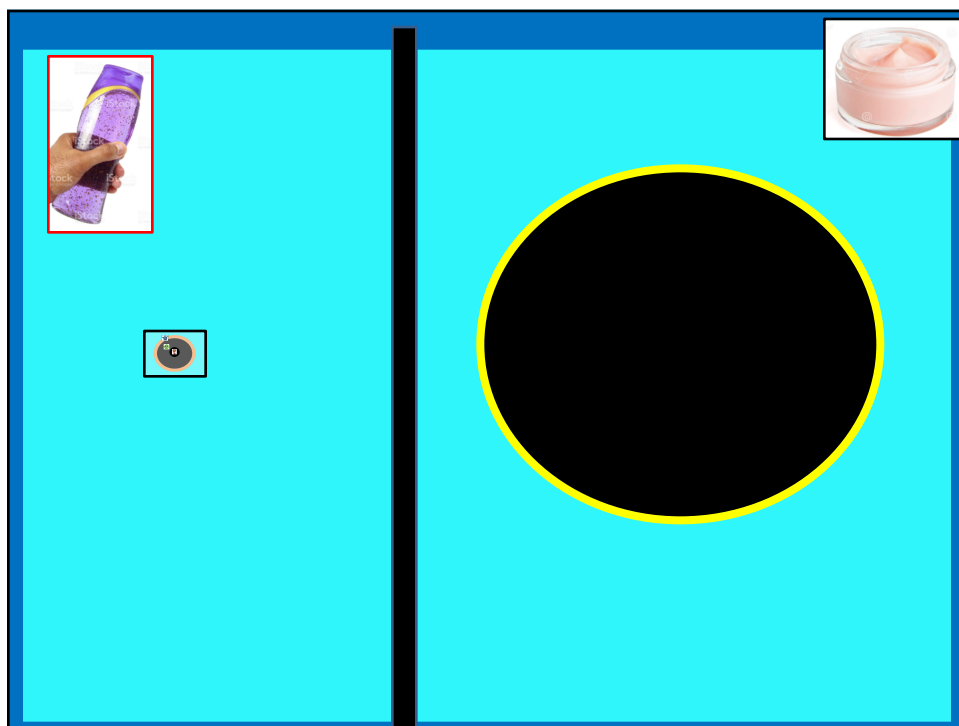
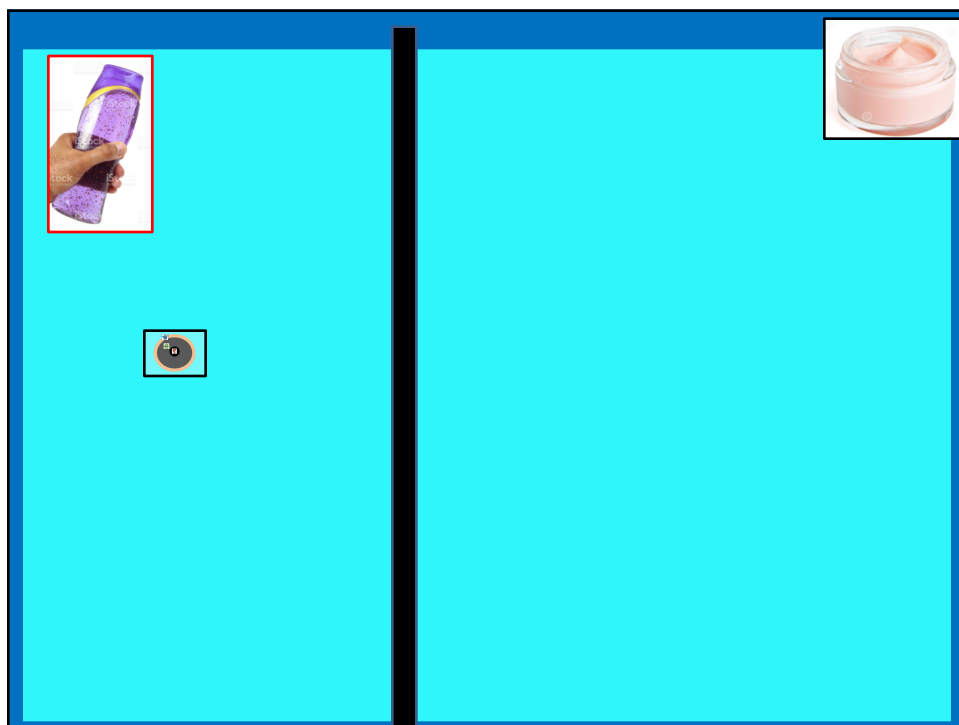

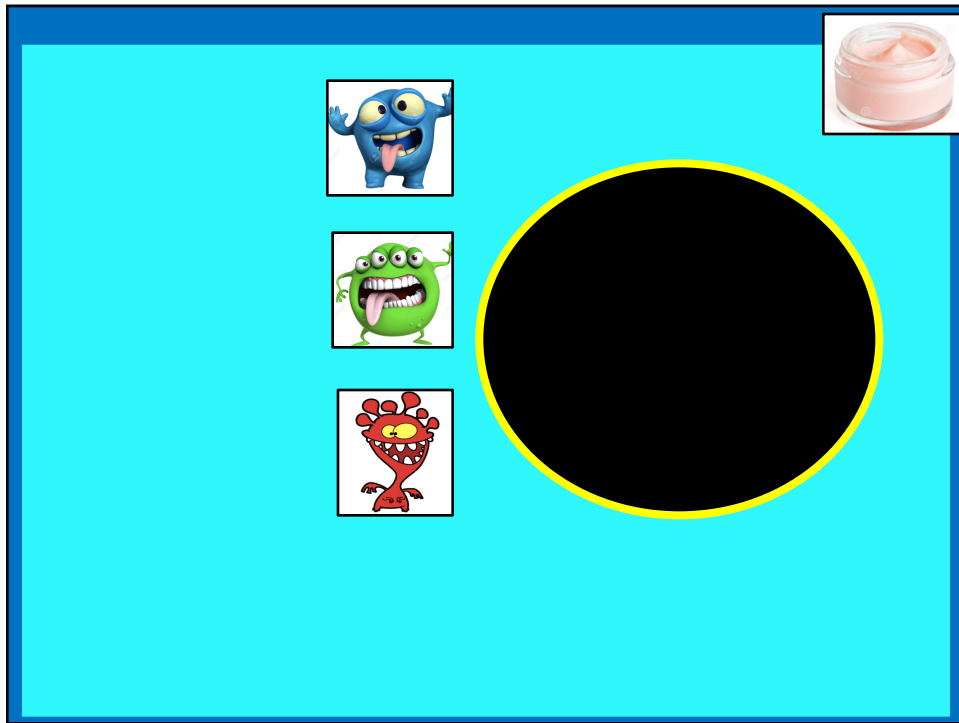
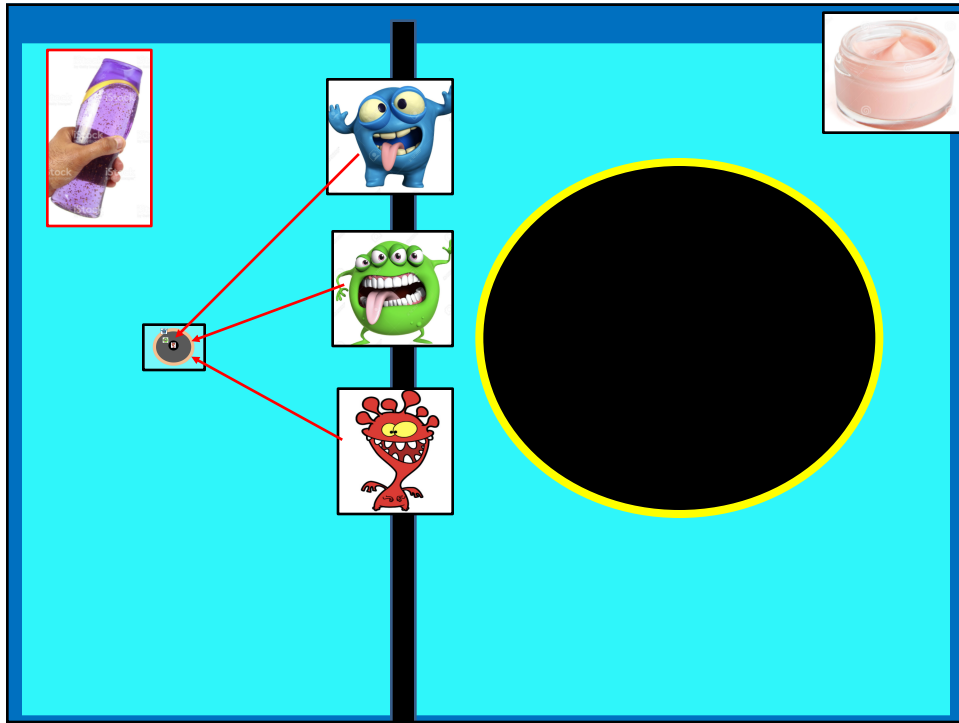

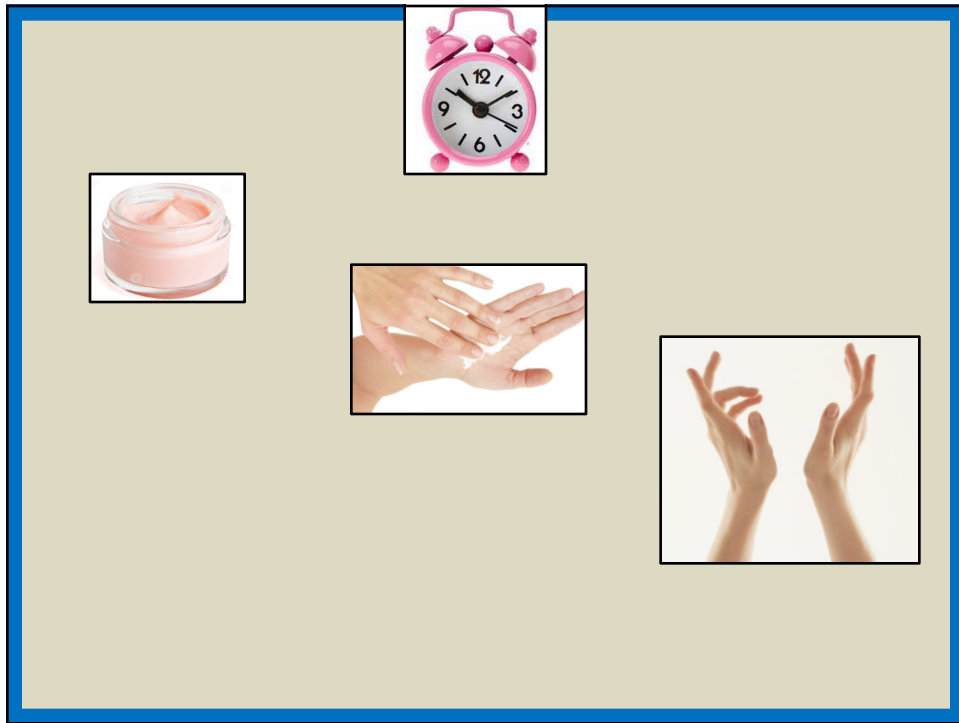

Depositos en PIEL de distintas Cremas y Lociones



Crema 1

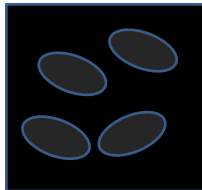

Crema 2

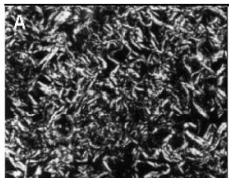

Crema 3

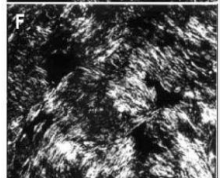

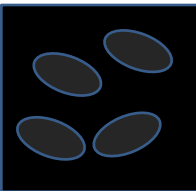

Crema 1

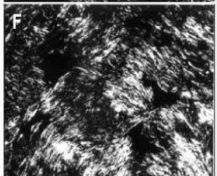
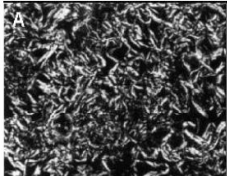

Fragancia "libre" para evaporarse y penetrar la piel

Fragancia "atrapada" ?





Fragancia
"atrapada" ?



LONGEVIDAD

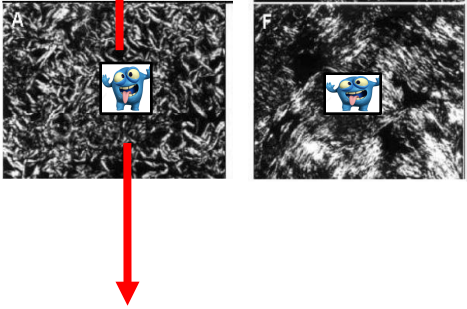

Distintos Olores Residuales

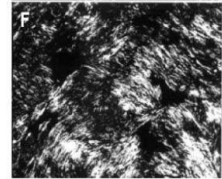
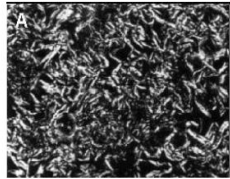
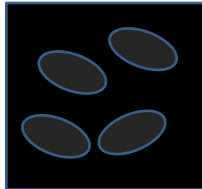

Independientemente del tipo de producto

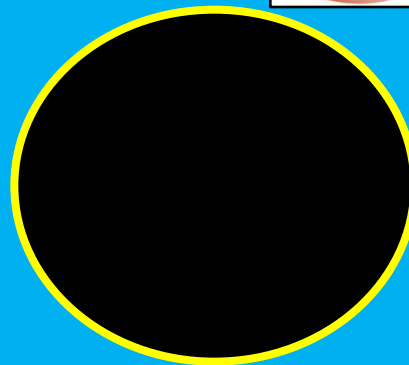
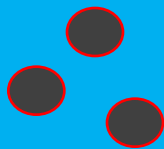



El AGUA esta presente

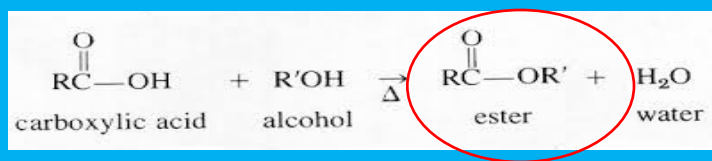

El AGUA esta presente

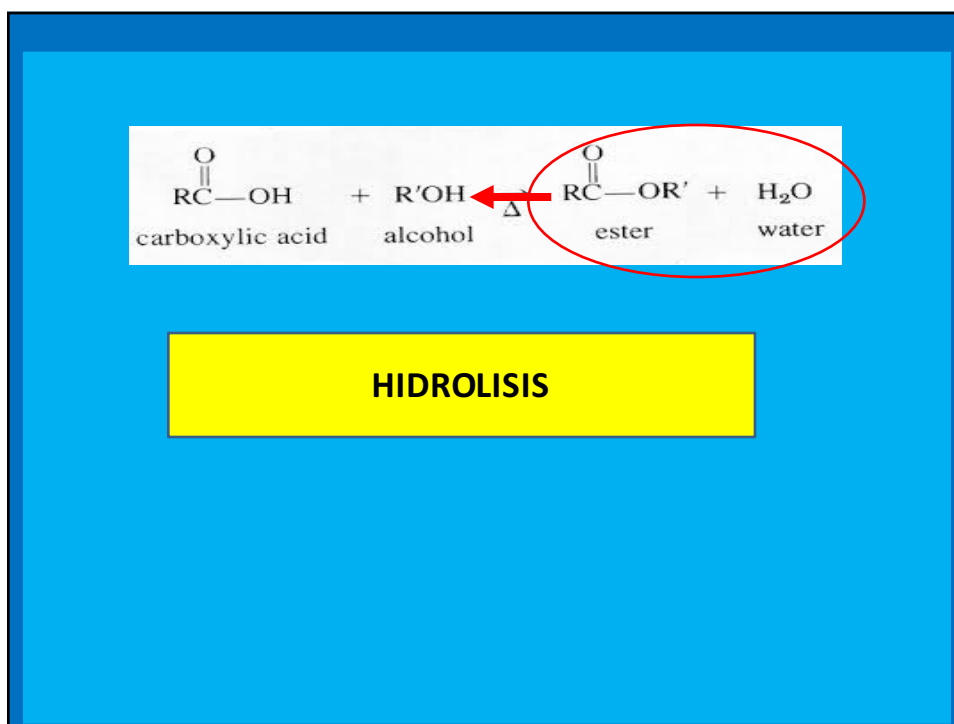
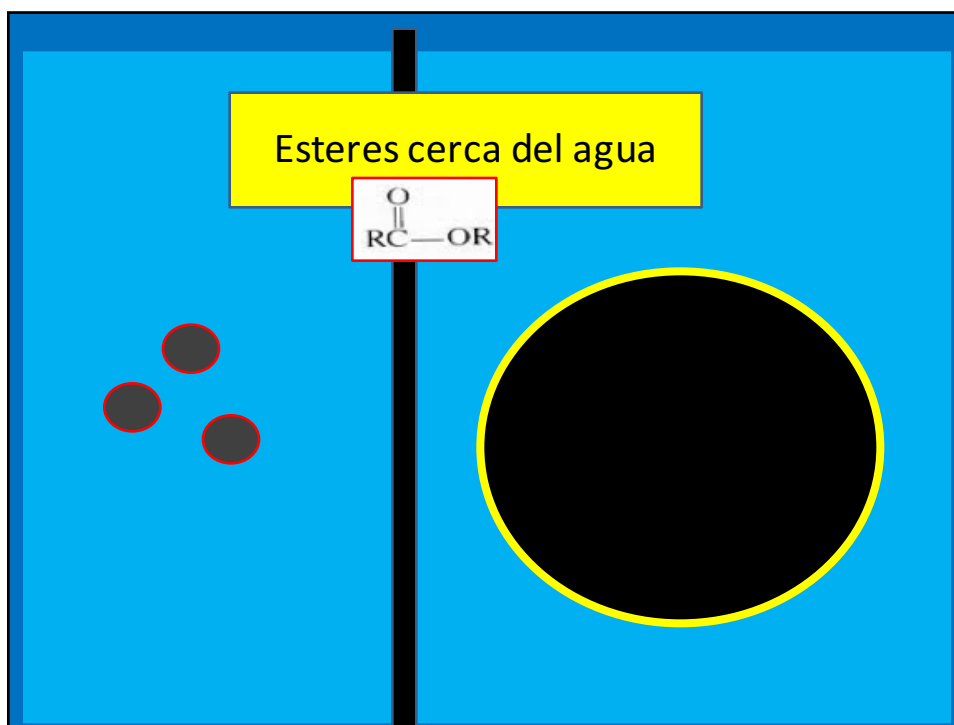

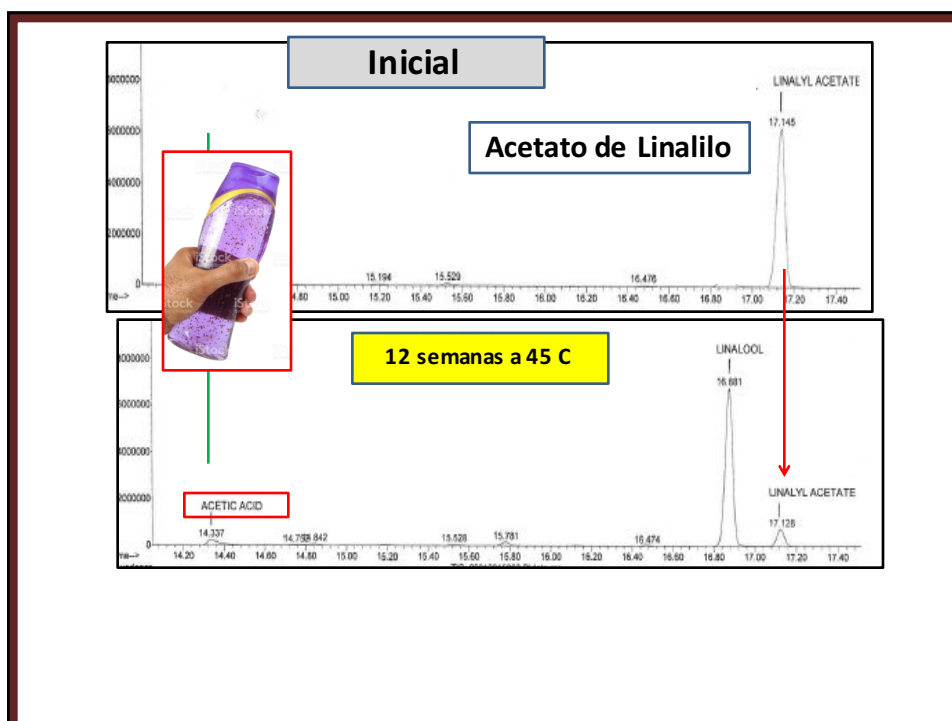
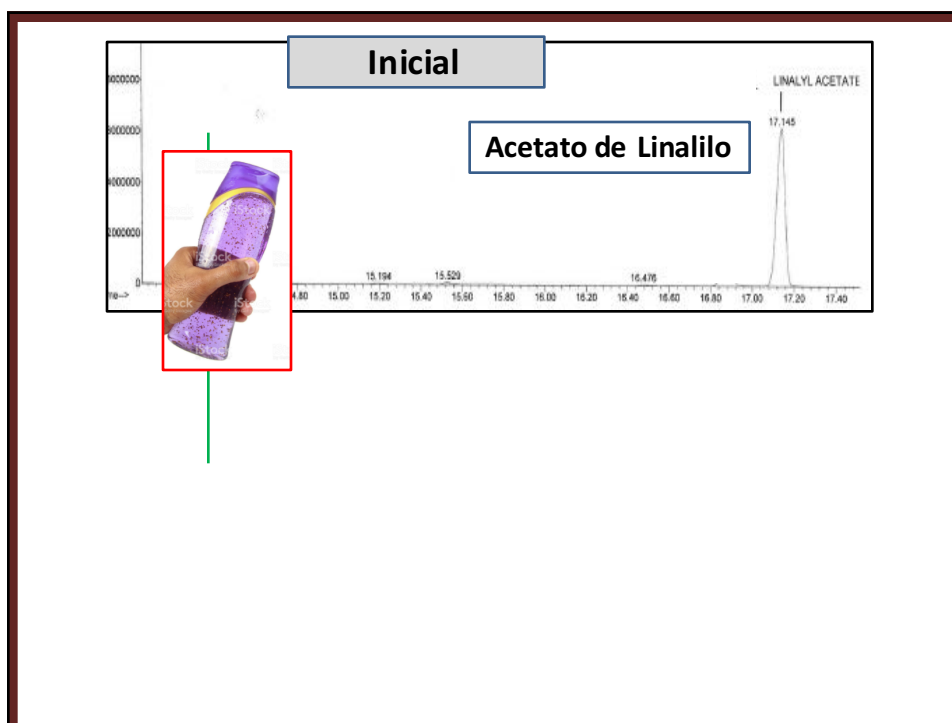

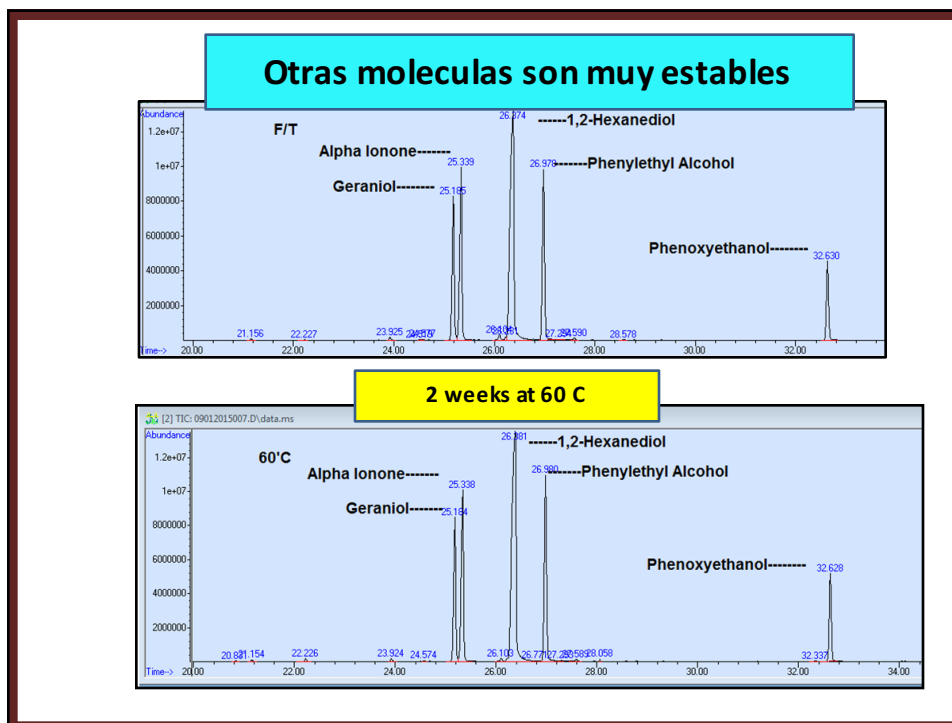

**Numero de dias para que desaparezca
el 50% del ester a 45 C**

	pH 3	pH 4	pH 5	pH 6	pH 7	pH 8	pH 9	pH 10
BENZYL FORMATE	1	3	7	4	1	0	0	0
BENZYL ACETATE	22	120	322	427	281	92	15	1
BENZYL PROPIONATE	30	143	391	620	569	303	93	17
BENZYL BUTYRATE	73	260	586	839	764	442	163	38
BENZYL ISOBUTYRATE	403	752	1090	1226	1071	727	383	157
BENZYL SALICYLATE	>>365	>>365	2975	630	133	28	6	1
BENZYL BENZOATE	> 365	> 365	> 365	> 365	> 365	736	288	113
BENZYL PHENYL ACETATE	83	389	916	1092	659	201	31	2
BENZYL TIGLATE	> 365	> 365	> 365	> 365	> 365	> 365	> 365	> 365
EUGENYL ACETATE	239	476	493	266	74	11	1	0
EUGENYL PHENYL ACETATE	727	774	529	232	65	12	1	0
ANISYL ACETATE	27	112	264	363	290	135	36	6
CINNAMYL ACETATE	115	354	632	659	400	141	29	3
CINNAMYL CINNAMATE	9377	7232	4482	2232	893	287	74	15
CITRONELLYL ACETATE	65	243	573	842	774	445	160	36
LINALYL ACETATE	8	13	18	23	26	27	25	21
GERANYL ACETATE	89	234	423	523	442	255	101	27



**Formulaciones
SIN y CON
Fragancia**



**Estabilidad a
5, 20, 30, 40, 45 y 55 C**

**Leer el pH o
El Indice de Acidez**

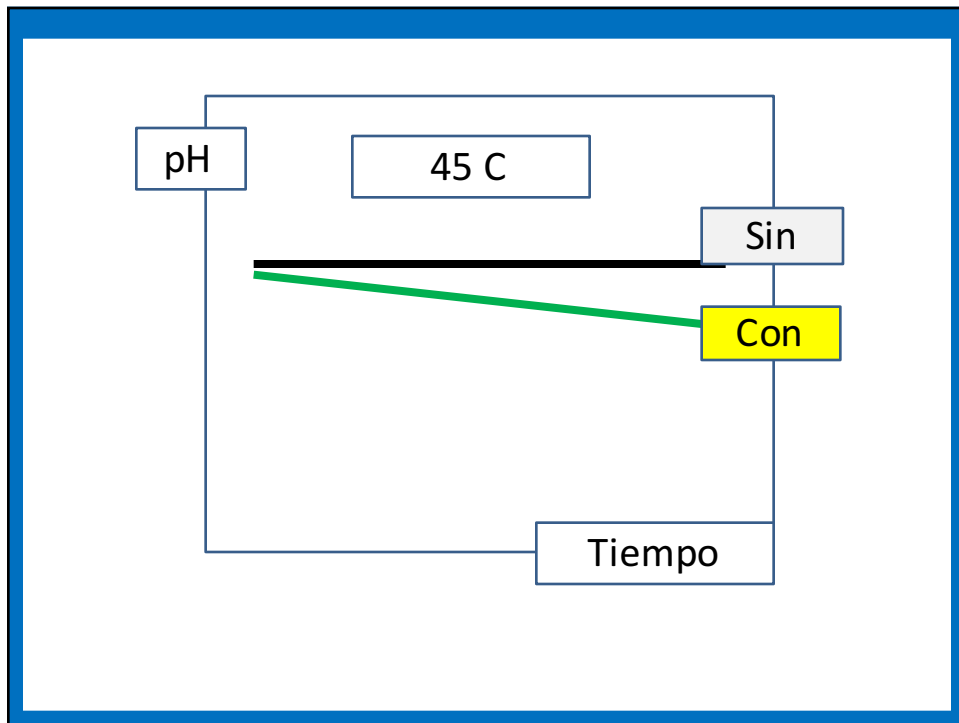
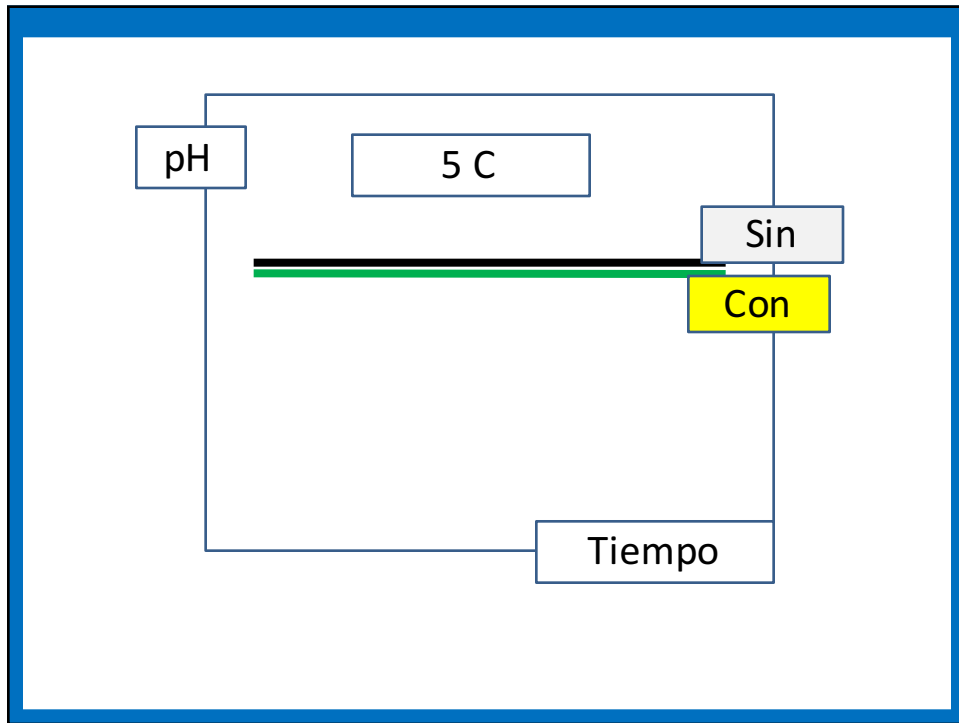

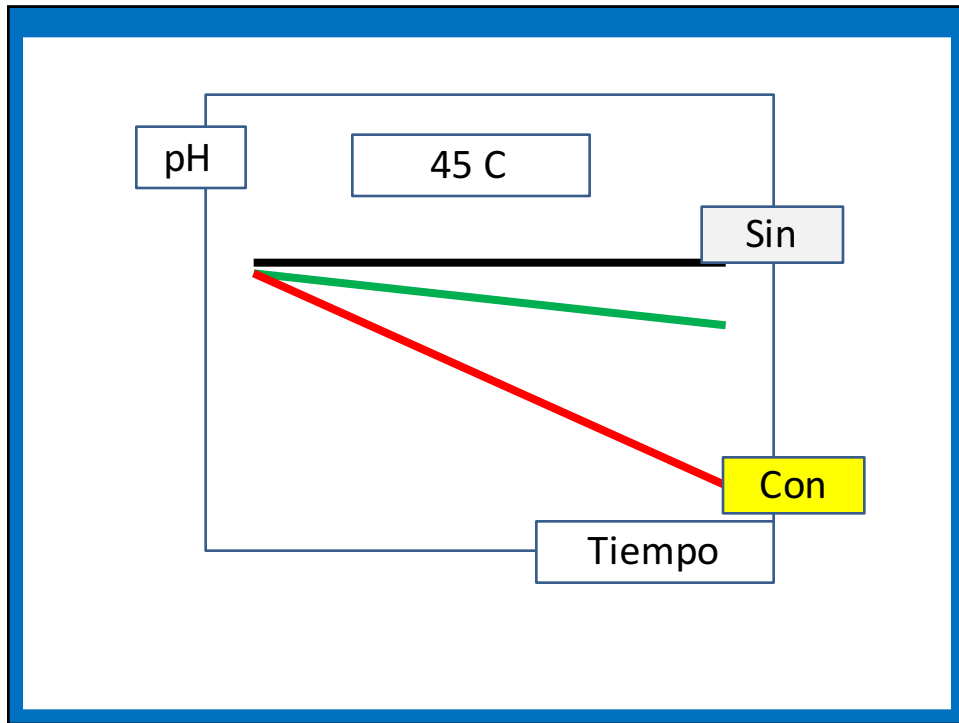

Caso Facil

Fragancias sin Definir

The block contains three images of cosmetic products. On the left is a clear glass perfume bottle with a silver cap. In the center is a hand holding a purple spray bottle with a white nozzle. On the right is a white jar of cream with a pink lid.